



# CLINIC CATALOGUE

---

**2024**

# INDEX

Articulators	3
Instruments	5
Machines	19
Cleaning & Disinfection	30
Furniture	40
Alphabetical Index	43

## Arcon type articulator *Arquimedes professional* (semiadjustable) **A7 PLUS**

**Ref. 010099**  
Articulator + Case

Sturdy structure made of aluminum, ensuring greater stability. Design that provides greater visibility.

- Semi-adjustable / Arcon.
- Fixed intercondylar distance (110 mm).
- Curved condylar guide.
- Angle adjustment of the condilic guide.
- Angle adjustment of the Bennet guide.
- Central locking.
- Motion stabilizer system with silicone joint.
- Upper branch support pin in the open position.



## Arquimedes protrusal arcon type articulator (semiadjustable) **A7 PLUS-E**

**Ref. 010103**  
Artikulator + Box

Similar to the Archimedes Pro model, it has exclusive aluminum condylar guides with millimeter adjustment.

- Semiadjustable / Arcon.
- Fixed intercondylar distance (110 mm).
- Regulable condylar guide.
- Regulable Bennet angle.
- Flat condylar guide.
- Bilateral locking system.
- Support for upper branch in open position.
- Stabilization system of the condilar guide movement with spring.



## Arcon type articulator *4.000 S* (semiadjustable)

**Ref. 010107**  
Articulator + Case

- Semi-adjustable / Arcon.
- Fixed Intercondylar distance (110 mm).
- Condilar guide fixed on the average: 30°.
- Bennet angle fixed on the average: 15°.
- Condilar curve guide.
- Motion stabilizer system with magnet for the condylar guide.
- Upper branch support pin in the open position.



## Arquimedes Junior (semiadjustable) **A7 FIX**

**Ref. 010098**  
Articulator + Cardboard box

- Semi-adjustable / Arcon.
- Adjustable intercondylar distance in (expander spindle).
- Curved condilic guide.
- Condilic guide angle adjustment.
- Bennet angle adjustment
- O-ring stabilization system.



## Standard facial bow

Medical device

**Ref. 010102-50**  
Bow Standard

The Standard face bow is an instrument to record the spatial position of the patient's upper arch and transfer it to the articulator. The transfer of this position is by attaching the complete facial bow to the articulator.

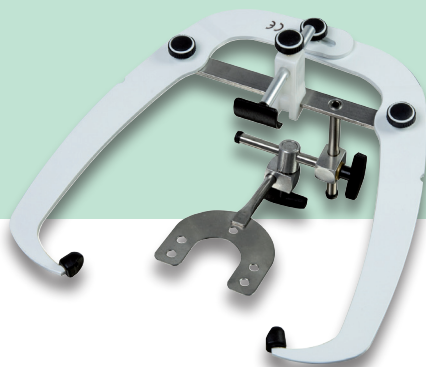

## Elite facial bow

Medical device

**Ref. 010100-55**  
Bow Elite

The Elite face bow has a fork articulation and fixation system that allows a faster registration for the professional and comfortable for the patient, besides a transfer set that eliminates the need for the arch in the process of assembling the models in the articulator, making this process more practical and stable.

His nazium rapporteur with adjustable height allied to the infra-orbital indicator, makes the record even more precise.

The bow is equipped with a smooth sliding system (opening and closing) that facilitates its handling. Its atria are anatomical, removable and autoclavable.

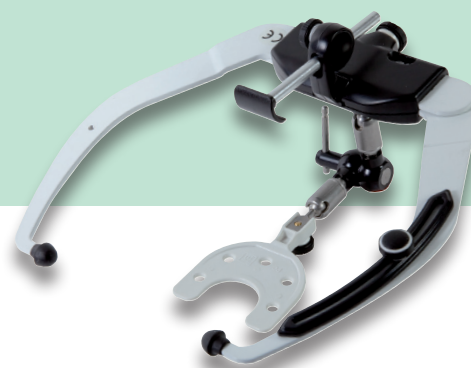

**Ref. 010099**  
Articulator + Case



**Ref. 010103**  
Articulator + Case



**Ref. 010107**  
Articulator + Case



**Ref. 010098**  
Articulator +  
Cardboard box



### DIMENSIONS

Model	Ref. 010098	Ref. 010099	Ref. 010103	Ref. 010107
Height (mm)	150	150	170	160
Width (mm)	180	170	170	148
Depth (mm)	180	180	180	180
Weight	0,540 kg	0,689 kg	0,735 kg	0,697 kg

The 4 models are perfectly compatible with the Standard and Elite face bows.

### Range of accessories:

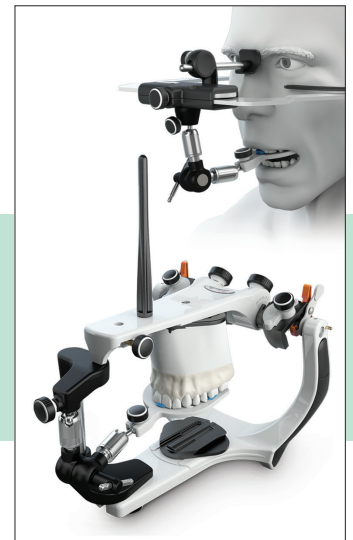
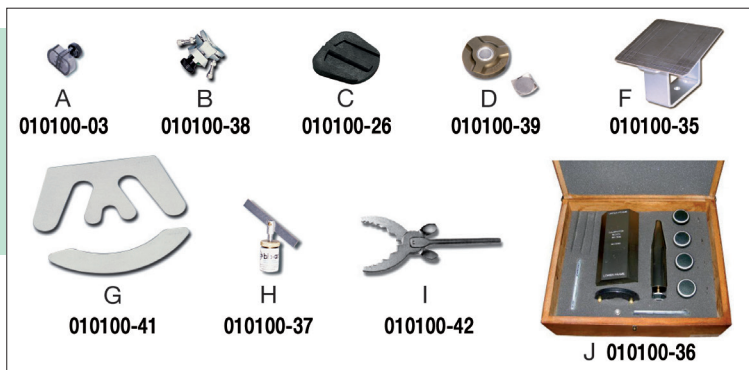

### MORE INFORMATION

<https://mestra.es/producto/arquimedes-articulators>

## Plastic articulator

(for dental correction models) 50 u. Ref. 010110

Clean and useful for storing and presenting dental correction patterns

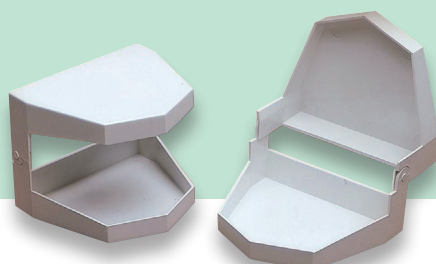

63 mm  
67 mm  
79 mm  
DIMENSIONS  
4  
0,026 kg

## Double guide occlusion device

(for maxillary orthopaedics) Ref. 010130



95 mm  
20 mm  
105 mm  
DIMENSIONS  
0,498 kg

## Spatulas



		Total length	Blade	
1. Ref. 060001	Alginate spatula. Stainless steel (white handle)	205 mm	110 mm	0,061 kg
2. Ref. 060002	Plaste Ref. alginate spatula (Plastic) 12 units	208 mm	90 mm	0,024 kg
3. Ref. 060003	Alginate spatula. Stainless steel (white handle)	190 mm	90 mm	0,037 kg
4. Ref. 060000	Alginate spatula.	230 mm	110 mm	0,075 kg

## Dappen glasses



Colour	
Amber (12 unids.)	Ref. 070161
Blue (12 unids.)	Ref. 070162
Transparent (12 unids.)	Ref. 070163
Green (12 unids.)	Ref. 070164

Ø 33 x (H) 35 mm	0,042 kg (1 u.)
(L) 160 x (W) 110 x (H) 40 mm (12 u.)	0,635 kg (12 u.)

## Mouth mirrors

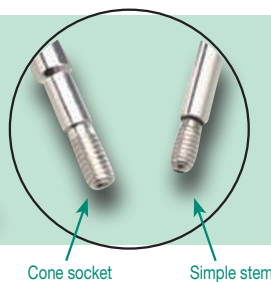

Paking (12 u.)	(L) 84 x (W) 52 x (H) 28 mm	0,080 kg Aprox.
----------------	-----------------------------	-----------------

## Magnetic bar (instrument holder)

Ref. 050362



Easy to fit and may be secured by bolts to almost any surface (Spatulas not included).

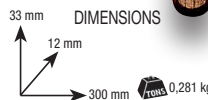

## Alginate mixing bowl Ref. 060120



Diameter	Height	Capacity	
110 mm	78 mm	400 cm <sup>3</sup>	0,100 kg

## Dappen glass support Ref. 070165

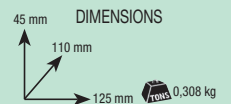

Completely manufactured in polished stainless steel with transparent silicone legs to avoid sliding. It is very useful and convenient to organize the worktable. It has 6 different cavities for glasses. (Glasses not included).

Top quality mirrors meeting all THE required standards. They all are plane with stainless steel chassis. They are available in silver (normal) and rhodium. In the case of rhodium, reflecting surface is in the upper part of the mirror, so that light does not have to make two changes of element (air/glass; glass/air) creating different refraction angles. As a result the image is more clear and with no distortions. There are four different sizes: Plane n°3, n°4, n°5 and n°6. These also have two kinds of thread: cone socket and simple stem.

	Plane	Normal	Rhodium
Cone socket	N° 4	070551	070560
	N° 5	070552	070561
	N° 6	070553	
Simple stem	N° 3	070555	
	N° 4	070556	070565
	N° 5	070557	070566

## Modelling carvers

Ref. 070320 (Set 6 units)

Ref. 070330 (Set 5 units)

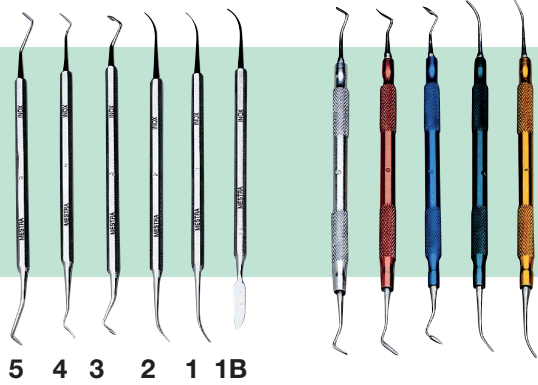

5 4 3 2 1 1B

## Clamp holder: sterilizable

Ref. 070110



Made of silicone. Sterilizable. Clamps not included.

(L) 120 x (W) 68 x (H) 15 mm 0,064 kg

## Cement spatulas

- 178 mm 0,019 kg 0 Ref. 060240
- 175 mm 0,020 kg 1 Ref. 060242
- 175 mm 0,020 kg 2 Ref. 060244
- 178 mm 0,021 kg 3 Ref. 060246
- 175 mm 0,021 kg 4 Ref. 060248
- 195 mm 0,022 kg 5 Ref. 060250

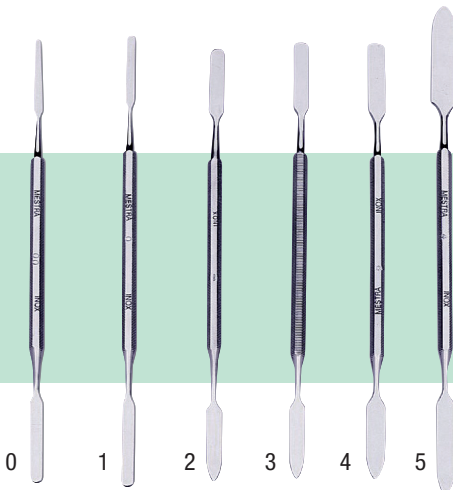

## Dam perforator

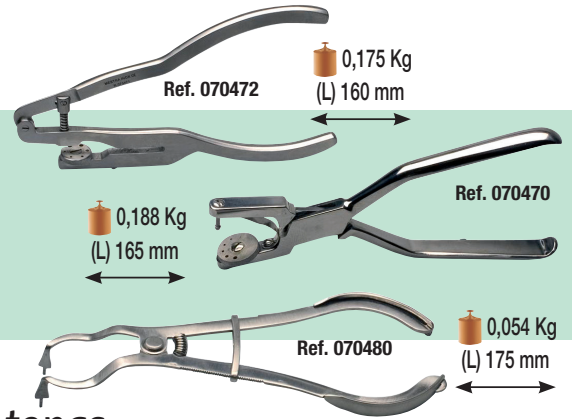

## Clamp tongs

## Plier holding support

Ref. 050364

A simple and practical tabletop component which helps to keep the work area tidy. When the pliers are kept in the support, they are always in view, and the technician does not have to open or close any drawers. (Pliers not included).

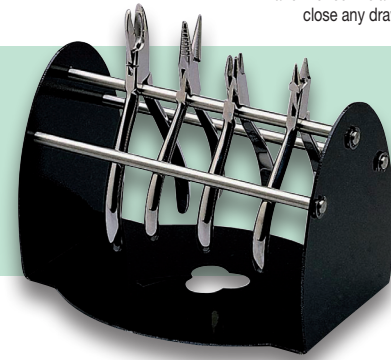

165 mm  
140 mm  
200 mm 1,123 kg

## Stainless steel holder

for instruments Ref. 060235

Completely made of stainless steel. It can hold up to 7 instruments. Its staiRef. shape design makes selection easier.

Sold without instruments.

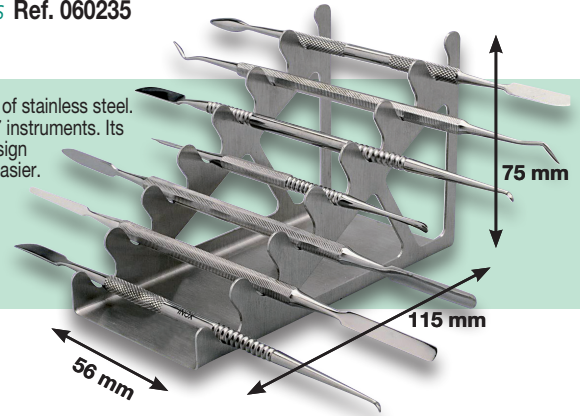

## Bending pliers

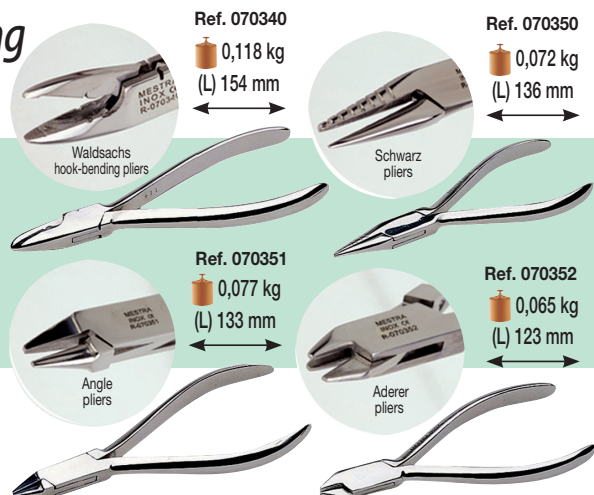

## Plier Mathieu Ref. 070356

Ref. 070356  
0,031 kg  
(L) 143 mm

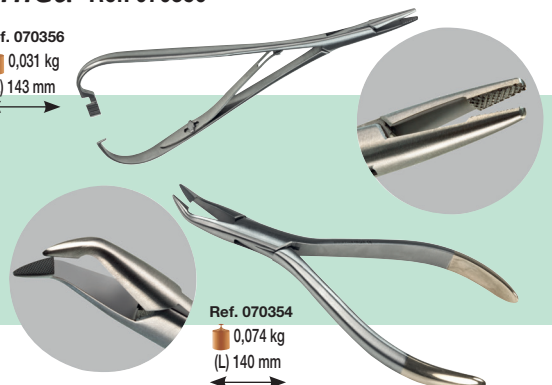

## Plier Weingart Ref. 070354

## Standard wire folding pliers

Ref. 070339

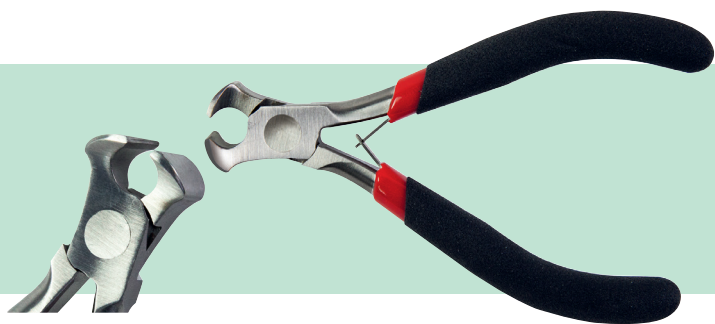

DIMENSIONS

(L) 108 x (W) 65 x (H) 15 mm 0,070 Kg

## Mirror handle

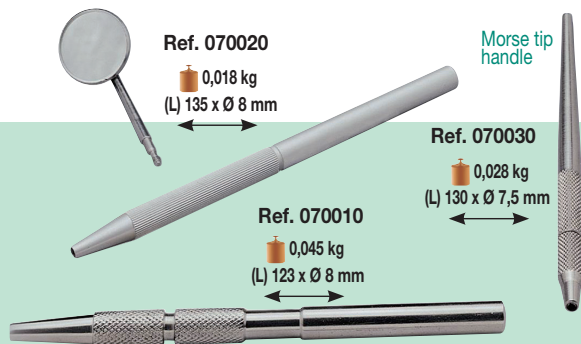

Ref. 070020  
 0,018 kg  
(L) 135 x Ø 8 mm

Morse tip handle

Ref. 070030  
 0,028 kg  
(L) 130 x Ø 7,5 mm

Ref. 070010  
 0,045 kg  
(L) 123 x Ø 8 mm

Ref. 070010 Made of stainless steel.

Ref. 070020 Made of anodized aluminium. Colour: silver.

Ref. 070030 Made of stainless steel, securely clamping the points as the clamp is divided into three sections.

## Crown removing hammer



Totally made of polished stainless steel.

Ref. 070035-04 Long Tip  
Ref. 070035-05 Short Tip

## Amalgam applier

Until end of stock

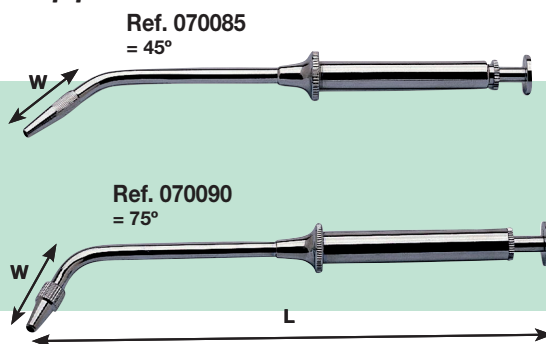

Ref. 070085  
= 45°

Ref. 070090  
= 75°

Ref. 070085	(L) 145 x (W) 26 x Ø 14 mm	0,031 kg
Ref. 070090	(L) 133 x (W) 30 x Ø 14 mm	0,027 kg

## Tongs

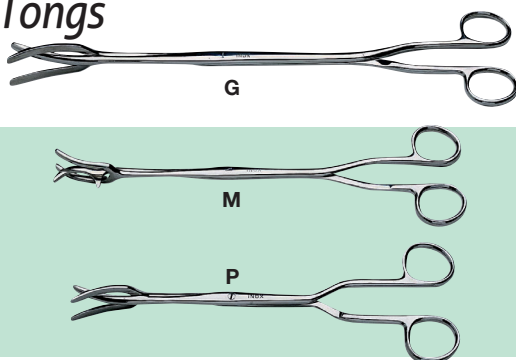

Ref. 070380 = G	(L) 300 x (W) 75 x (H) 25 mm	0,125 kg
Ref. 070390 = M	(L) 230 x (W) 66 x (H) 17 mm	0,059 kg
Ref. 070400 = P	(L) 200 x (W) 72 x (H) 20 mm	0,059 kg

## Mixing mortar

Ref. 060140

Made of stainless steel



Ø 38 x (H) 34 mm	0,112 kg
(L) 40 x (W) 40 x (H) 39 mm	0,118 kg

## Matrix retainer (universal)

Ref. 070409

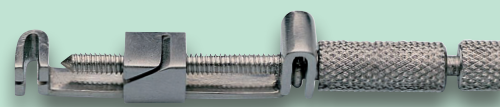

9 mm DIMENSIONS  
9 mm  
63 mm 0,014 kg

## Base former with magnet

Ref. 050110=SP Ref. 050120=IP  
Ref. 050130=SG Ref. 050140=IG

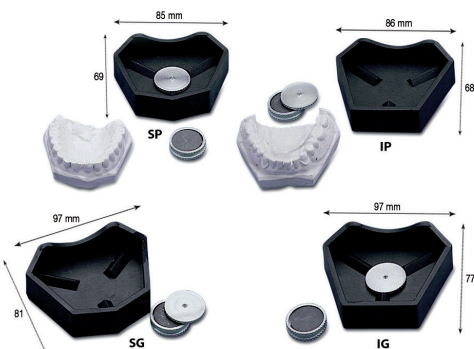

INSTRUCTIONS FOR USE

1. Fit the base former with the metal plate.
2. Empty the impression as usual.
3. Insulate the model and fit the magnet on the metal plate.
4. Make the counterform that will remain fixed in the articulator by pouring coating plaster on the model; let it polymerize. Then separate the model carefully from the counterform (which can be reused for another model).

## Model formers (for orthodontics training)



S = Upper	I = Lower	S = Upper	I = Lower
Ref. 050060  0,081 kg	Ref. 050062  0,081 kg	Ref. 050064  0,073 kg	Ref. 050066  0,071 kg

## Cheek retractor

Made of plastic sterilizable at 135° C

Ref. 070054

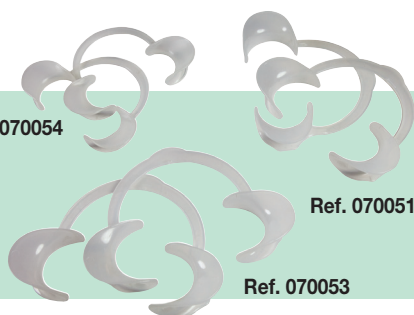

Ref. 070051

Ref. 070053

### DIMENSIONS

Ref. 070051	(L) 155 x (W) 10 x (H) 25 mm Paking (2 u.)	0,324 kg
Ref. 070053	(L) 155 x (W) 10 x (H) 25 mm Paking (2 u.)	0,355 kg
Ref. 070054	(L) 115 x (W) 70 x (H) 20 mm Paking (2 u.)	0,234 kg

## Lip retractor (2 units) double use

Ref. 070052 Made of plastic sterilizable at 135° C



### DIMENSIONS

(L) 150 x (W) 45 x (H) 20 mm (1 u.)	0,019 kg
(L) 170 x (W) 55 x (H) 30 mm Paking (2 u.)	0,038 kg

## Lip retractor

Ref. 070058 A Made of plastic sterilizable at 135° C

Ref. 070058 B

Ref. 070058 C

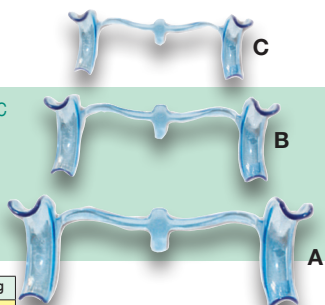

### DIMENSIONS

Ref. 070058 A	(L) 126 x (W) 50 x (H) 53 mm Paking (1 u.)	0,010 kg
Ref. 070058 B	(L) 105 x (W) 48 x (H) 48 mm Paking (1 u.)	0,009 kg
Ref. 070058 C	(L) 98 x (W) 42 x (H) 40 mm Paking (1 u.)	0,007 kg
Ref. 070058	(L) 145 x (W) 60 x (H) 55 mm  Paking (2 u.)	0,034 kg

## Napkin holder (10 units)

Ref. 070060

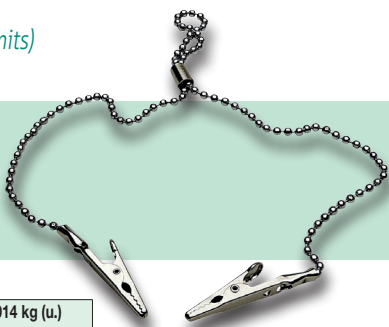

### DIMENSIONS

(L) 520 mm (u.)	0,014 kg (u.)
(L) 100 x (W) 120 x (H) 30 mm (aprox.)	0,161 kg (10 u.)

## Fox plane (plastic)

Ref. 070510

Made of plastic sterilizable at 135° C



(L) 180 x (W) 130 x (H) 6 mm	0,038 kg
------------------------------	----------

## Lip retractor

Ref. 070055 Made of plastic sterilizable at 135° C

### DIMENSIONS

(L) 120 x (W) 53 x (H) 18 mm (1 u.)	0,008 kg
(L) 145 x (W) 60 x (H) 25 mm Paking (2 u.)	0,028 kg



## Lip retractor Ref. 070056

Made of plastic sterilizable at 135° C

### DIMENSIONS

(L) 115 x (W) 42 x (H) 18 mm (1 u.)	0,008 kg
(L) 140 x (W) 50 x (H) 25 mm Paking (2 u.)	0,026 kg



## Lip retractor

Ref. 070057 A Made of plastic sterilizable at 135° C

Ref. 070057 B

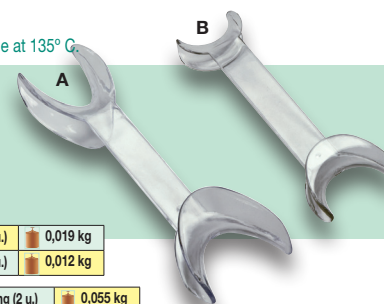

### DIMENSIONS

Ref. 070057 A	(L) 166 x (W) 55 x (H) 20 mm Paking (1 u.)	0,019 kg
Ref. 070057 B	(L) 145 x (W) 45 x (H) 16 mm Paking (1 u.)	0,012 kg
Ref. 070057 A	(L) 190 x (W) 60 x (H) 35 mm  Paking (2 u.)	0,055 kg
Ref. 070057 B	(L) 175 x (W) 50 x (H) 50 mm  Paking (2 u.)	0,044 kg

## Lip retractor

Ref. 070059 Made of plastic sterilizable at 135° C



### DIMENSIONS

(L) 73 x (W) 70 x (H) 28 mm (1 u.)	0,005 kg
(L) 130 x (W) 70 x (H) 80 mm Paking (10 u.)	0,052 kg

## Drill cleaning tongs

Ref. 070520



### DIMENSIONS

(L) 156 x (W) 45 x (H) 40 mm	0,021 kg
------------------------------	----------

Ideal for immersion of drills and other small items in disinfectant baths, ultrasonic equipment and autoclaves. Made of stainless steel.

## Cofferdam arc holder

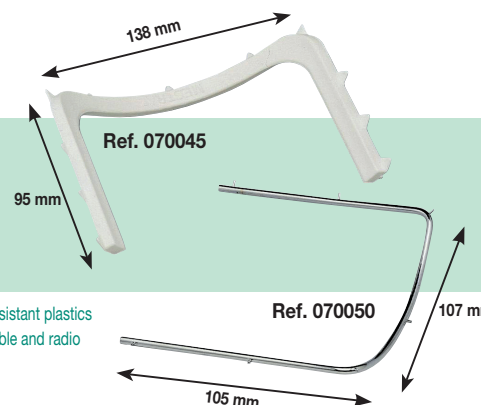

Ref. 070045 of special heat-resistant plastics allowing it to be sterilized, unbreakable and radio transparent.

Ref. 070050 Made of metal.



## Germicide box for burs

Ref. 070530  
(stainless steel)



DIMENSIONS

Ø 70 x (H) 35 mm 0,119 kg

## Magnetic bur holder R - 070115

Very practical with an attractive design. Its small size means it can be placed anywhere. Supplied in a batch of three products. Colours: red, green and blue. Ø 62 mm

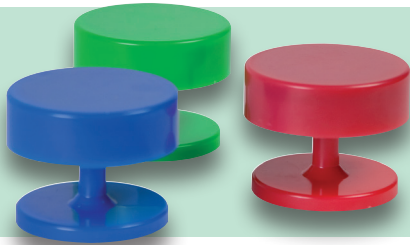

DIMENSIONS

Ø 62 x (H) 49 mm (1 u.) 0,182 kg

(L) 200 x (W) 40 x (H) 60 mm Paking (3 u.) 0,583 kg

## Bur holder (plastic) Ref. 070142

DIMENSIONS

Ø 90 x (H) 66 mm 0,065 kg

(L) 91 x (W) 91 x (H) 71 mm 0,088 kg



Ref. 070142

## Bur holder (Clinic) Ref. 070150

Burs held by means of a magnet. Made of (ferritic) stainless steel with plastic casing.

DIMENSIONS

(L) 115 x (W) 45 x (H) 45 mm 0,180 kg

Ref. 070150



## Alcohol lamp

(stainless steel) Ref. 070065

Ø 76 x (H) 54 mm 0,100 kg



## Alcohol lamp

(glass) Ref. 070070

Ø 60 x (H) 83 mm 0,192 kg

## Germicide box for burs

Ref. 070531



DIMENSIONS

Ø 90 x (H) 80 mm 0,122 kg

## Bur holder (plastic; sterilizable)

Ref. 070120 = FG  
Ref. 070125 = CA  
Ref. 070130 = FG+CA  
Ref. 070135 = Laboratory



DIMENSIONS

Ref. 070120	(L) 75 x (W) 60 x (H) 35 mm	0,060 kg
Ref. 070125	(L) 75 x (W) 60 x (H) 35 mm	0,060 kg
Ref. 070130	(L) 75 x (W) 60 x (H) 35 mm	0,060 kg
Ref. 070135	(L) 75 x (W) 60 x (H) 55 mm	0,072 kg

Only the base, made of temperature resistant plastic. Capacity for 36 pieces. Made for: FC, CA, FC+CA, laboratory.

## Bur holder (Aluminium)

Ref. 070151 = FG  
Ref. 070152 = CA

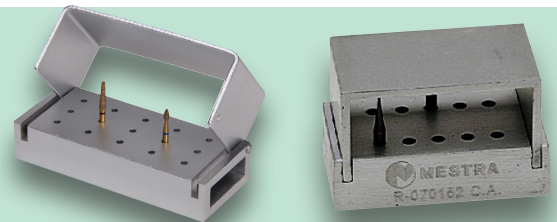

DIMENSIONS

Ref. 070151= FG	(L) 60 x (W) 25 x (H) 29 mm	0,04 kg
Ref. 070152= CA	(L) 40 x (W) 25 x (H) 27 mm	0,04 kg

## Dirty cotton container

(stainless steel) Ref. 070155



Ref. 070155



Ref. 070160

## Clean cotton container

(stainless steel) Ref. 070160

Ø 60-51 x (H) 77 mm 0,300 kg

## Cotton roll dispenser

Ref. 070061

Ref. 070062



Made of plastic sterilizable at 135° C.

Ref. 070061	(L) 120 x (W) 97 x (H) 55 mm	0,182 kg
Ref. 070061	(L) 120 x (W) 105 x (H) 60 mm	0,205 kg
Ref. 070062	(L) 108 x (W) 100 x (H) 52 mm	0,272 kg
Ref. 070062	(L) 120 x (W) 105 x (H) 60 mm	0,293 kg

## Liquid doser

Ref. 070650



400 cc capacity bottle, ideal for dosing all types of liquids easily and accurately. It can be handled using just one hand. Two scales: one in millimetres and the other in doses for preparing the alginate

### DIMENSIONS

$\varnothing$ 77 x (H) 200 mm	0,061 kg
(L) 205 x (W) 80 x (H) 80 mm	0,102 kg

## Glass dispenser

Plastic  
Ref. 070491

Metal  
Ref. 070490



### DIMENSIONS

Ref. 070491	(L) 320 x (W) 100 x (H) 113 mm	0,354 kg
Ref. 070491	(L) 340 x (W) 135 x (H) 122 mm	0,490 kg
Ref. 070490	(L) 358 x (W) 85 x (H) 85 mm	0,777 kg
Ref. 070490	(L) 373 x (W) 95 x (H) 95 mm	0,860 kg

## Orthodontic and denture boxes

Made of plastic; 25 units; assorted colours

Ref. 070600



Ref. 070605

Cord for boxes Supplied in 6 assorted colours (25 units). Length: 1 000 mm

### DIMENSIONS Ref. 070600

Paking (25 u.) (L) 300 x (W) 180 x (H) 160 mm	0,740 kg (25 u.)
---	------------------

## Boxes for orthodontic plates

Made of plastic. 25 units. Assorted colours

Ref. 070590



### DIMENSIONS

Paking (25 u.) (L) 240 x (W) 160 x (H) 140 mm	0,540 kg (25 u.)
---	------------------

## Denture boxes Plastic

Ref. 070000 Blue (100 units)

Ref. 070001 Pink (100 units)

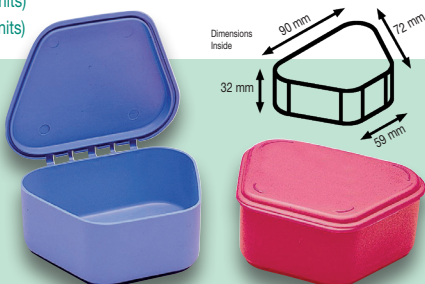

### DIMENSIONS

R.070000  Paking (100 u.) (L) 420 x (W) 380 x (H) 240 mm	3,420 kg (100 u.)
R.070000-25  (25 u.) (L) 300 x (W) 180 x (H) 160 mm	0,742 kg (25 u.)
R.070001  Paking (100 u.) (L) 420 x (W) 380 x (H) 240 mm	3,420 kg (100 u.)
R.070001-25  (25 u.) (L) 300 x (W) 180 x (H) 160 mm	0,742 kg (25 u.)

## Boxes for orthodontic plates

Made of plastic in different colours

Ref. 070002 (100 u.) Blue

Ref. 070006 (100 u.) Green

Ref. 070007 (100 u.) Light green

Ref. 070008 (100 u.) Orange

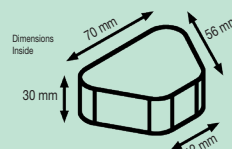

### DIMENSIONS

Paking (100 u.) (L) 345 x (W) 305 x (H) 195 mm	2,460 kg (100 u.)
Paking (25 u.) (L) 240 x (W) 160 x (H) 140 mm	0,535 kg (25 u.)

## Boxes for orthodontic plates

Made of plastic. Ref. 070622 5 u. assorted



## Boxes for orthodontic plates

Made of plastic. Ref. 070616 5 u. assorted

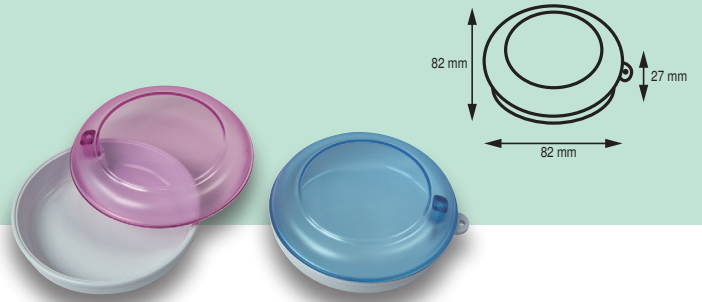

## Boxes for orthodontic plates

Made of plastic. Ref. 070618 5 u. assorted

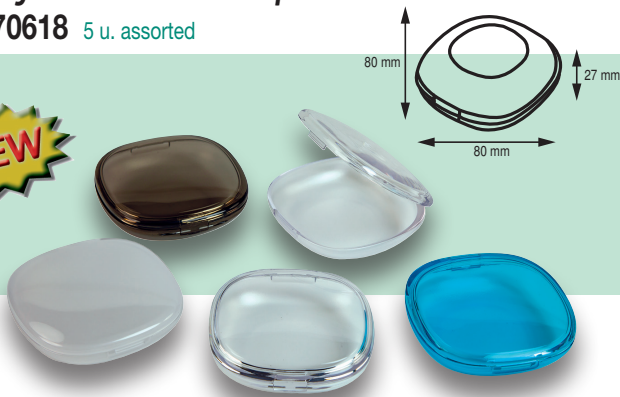

## Boxes for orthodontic plates

Made of plastic. Ref. 070620 Black

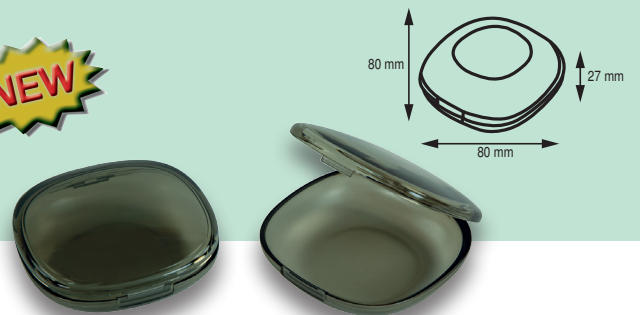

## Boxes for orthodontic models

(100 units) Ref. 070570

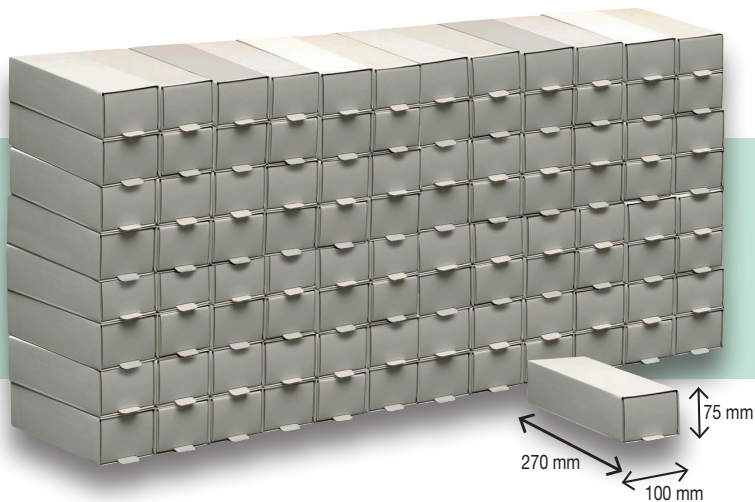

### DIMENSIONES

Paking (100 u.) (L) 555 x (W) 390 x (H) 335 mm 12,330 kg (100 u.)

## Container for models

Ref. 070003 6 models placed horizontally

Ref. 070004 12 models placed vertically



### DIMENSIONES

Ref. 070003 Paking (L) 230 x (W) 240 x (H) 58 mm 0,345 kg

Ref. 070004 Paking (L) 290 x (W) 220 x (H) 75 mm 0,425 kg

Ref. 070003

Ref. 070004

## Boxes with membrane (10 unit bags) safety lock

Ref. 100262	(L) 55 x (W) 49 x (H) 25 mm	0,023 kg u.
10 u.	(L) 147 x (W) 56 x (H) 56 mm	0,261 kg
Ref. 100263	(L) 60 x (W) 100 x (H) 22 mm	0,045 kg u.
10 u.	(L) 125 x (W) 105 x (H) 135 mm	0,475 kg
Ref. 100264	(L) 100 x (W) 100 x (H) 45 mm	0,081 kg u.
10 u.	(L) 430 x (W) 110 x (H) 100 mm	0,911 kg

Plastic

Specially designed for the transport and delivery of high quality elements. The inside is cushioned by a high flexibility membrane, which gives you the impression that the content inside is hanging in the air. Thanks to its transparency, the content can be seen from every angle and perspective.



Ref. 100262



Ref. 100263



Ref. 100264

## Boxes with membrane

(10 unit bags) without safety lock

Ref. 100259	(L) 23 x (W) 23 x (H) 25 mm	0,026 kg u.
Ref. 100260	(L) 50 x (W) 50 x (H) 25 mm	0,023 kg u.
Ref. 100261	(L) 75 x (W) 75 x (H) 40 mm	0,045 kg u.

Plastic



## Brackets boxes

Ref. 100263 B (10 unit bags) Plastic



Ref. 100259



Ref. 100260



Ref. 100261



Ref. 100263 (10 u.) (L) 60 x (W) 100 x (H) 22 mm 0,045 kg u.

## Boxes for models

Made of plastic

Large Ref. 070034 (50 units)

Small Ref. 070033 (50 units)

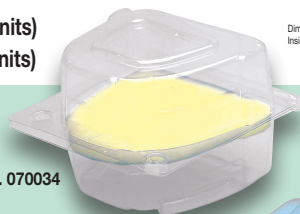
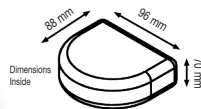

Ref. 070034



Ref. 070033

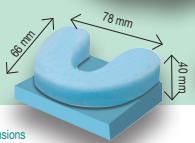

DIMENSIONES

Ref. 070033	Packing (50 u.)	(L) 290 x (W) 225 x (H) 255 mm	1,121 kg
Ref. 070034	Packing (50 u.)	(L) 290 x (W) 225 x (H) 255 mm	0,930 kg

## Transport and cleaning boxes

Made of plastic

Ref. 100265



(L) 115 x (W) 95 x (H) 46 mm	0,118 kg
(L) 120 x (W) 100 x (H) 50 mm	0,143 kg

## Boxes for prosthesis (with drain) (4 units)

Ref. 100267 Made of plastic



Ref. 100267	(L) 85 x (W) 76 x (H) 80 mm	0,082 kg
4 unidades	(L) 165 x (W) 165 x (H) 80 mm	0,389 kg

## Transport boxes

Made of plastic



Ref. 100255



Ref. 100256



Ref. 100255	(L) 29 x (W) 29 x (H) 23 mm	0,005 kg u.
50 u.	(L) 178 x (W) 150 x (H) 44 mm	0,289 kg- 50 u.

Ref. 100256	(L) 56 x (W) 44 x (H) 23 mm	0,011 kg u.
24 u.	(L) 280 x (W) 235 x (H) 23 mm	0,318 kg- 25 u.

## Model tray

(10 units each colour)

Useful when organizing Dental Lab production. Labels can be put on the frontal part and there is a spring to hold specification sheets.

These trays can be hung on the wall by a rail. (Ref. 100060) There are 5 colours available: yellow, blue, red, green and white.

They are supplied in packs of 10 units each colour.

Yellow	Ref. 100050
Blue	Ref. 100052
Red	Ref. 100054
Green	Ref. 100056
White	Ref. 100058

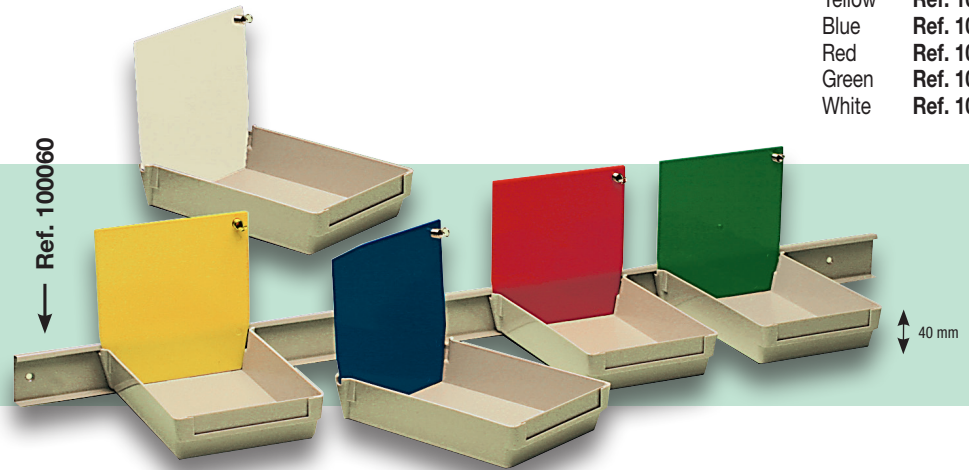
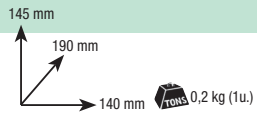

## Model tray large

(10 units each colour)

Similar to the previous model, but larger.

Yellow	Ref. 100062
Blue	Ref. 100064
Red	Ref. 100066
Green	Ref. 100068
White	Ref. 100069

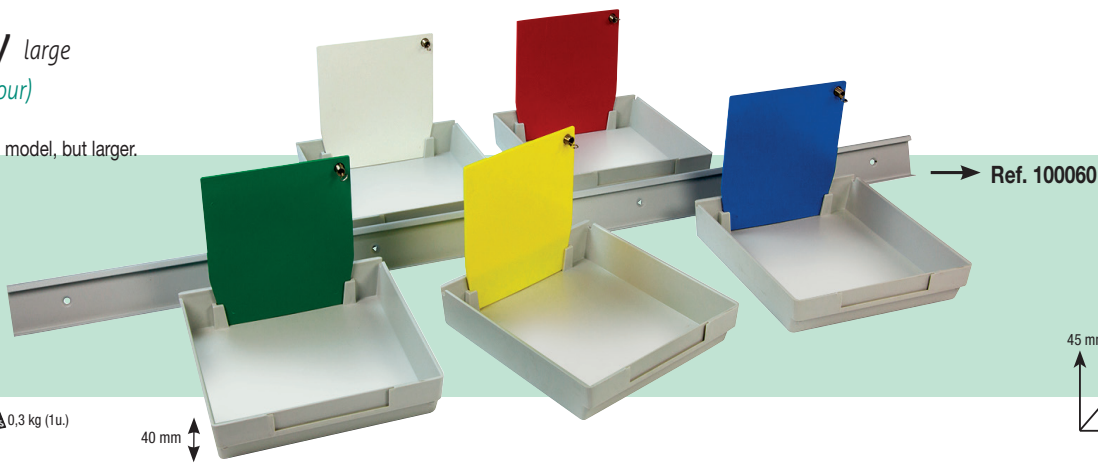
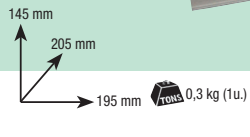

**Rail**  
Ref. 100060

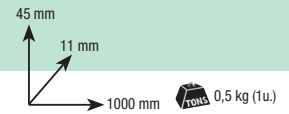

## Model tray tabletop

(10 units each colour)

Yellow	Ref. 100043
Blue	Ref. 100044
Red	Ref. 100045
Purple	Ref. 100046
White	Ref. 100047

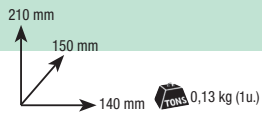

\*Not compatible with Ref. 100048 trolley  
\*Not compatible with Ref. 100060 rail

## Model tray high

(10 units each colour)



Ref. 100060



Yellow	Ref. 100071
Blue	Ref. 100072
Red	Ref. 100073
Green	Ref. 100074
White	Ref. 100075

## Instrument tray

Ref. 070444  
Ref. 070445

Made of anodized aluminium.  
Colour: silver

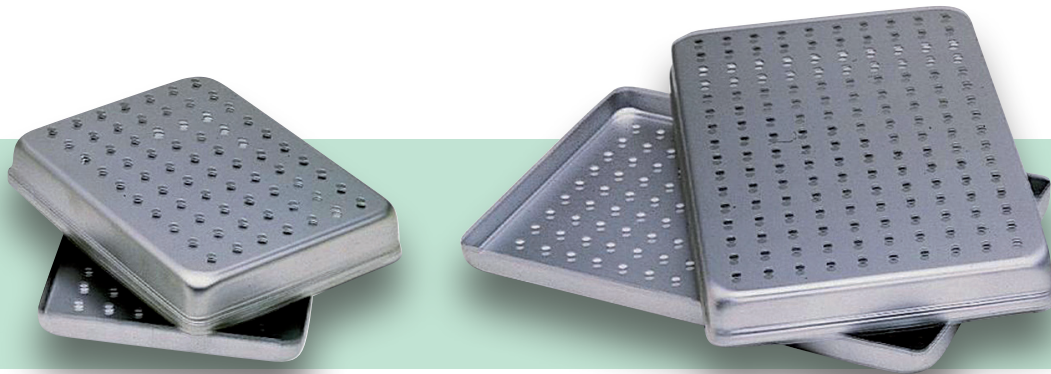

### DIMENSIONS

Ref. 070444 Pequeña	(L) 185 x (W) 145 x (H) 40 mm	0,241 kg
Ref. 070445 Grande	(L) 290 x (W) 190 x (H) 40 mm	0,400 kg

## Instrument tray

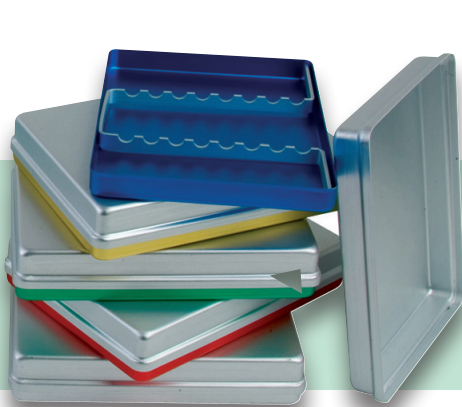

Little

Ref. 070430 = Silver  
Ref. 070431 = Gold  
Ref. 070432 = Red  
Ref. 070433 = Blue  
Ref. 070434 = Green

Made of anodized aluminium

Ref. 070430-1-2-3-4	(L) 185 x (W) 145 x (H) 40 mm	0,250 kg
---------------------	-------------------------------	----------



Big

Ref. 070439 = Green  
Ref. 070440 = Silver  
Ref. 070441 = Gold  
Ref. 070442 = Red  
Ref. 070443 = Blue

Ref. 070439-0-1-2-3	(L) 290 x (W) 185 x (H) 40 mm	0,414 kg
---------------------	-------------------------------	----------

## Box for endodontics Ref. 070410



Stainless steel box 18/8.  
Anodized aluminium plate.

### DIMENSIONS

Ref. 070410	(L) 210 x (W) 115 x (H) 45 mm	1,127 kg
-------------	-------------------------------	----------

## Ruler (for calibrating files) Ref. 070420

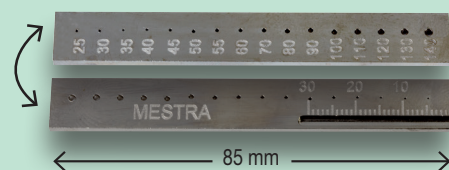

### DIMENSIONS

Ref. 070420	(L) 85 mm	0,017 kg
-------------	-----------	----------

## Mixing tips

These mixing tips are compatible with the main injection systems in the market.

Colour	R
Yellow (50 units.)	Ref. 100172
Yellow Points (50 units.)	Ref. 100176
Green (50 units.)	Ref. 100170
Light blue long (50 units.)	Ref. 100178
Light blue short (50 units.)	Ref. 100180
Pink (50 units.)	Ref. 100184
Brown (50 units.)	Ref. 100187
Points 1,06 mm (50 units.)	Ref. 100187-01
Points 2,00 mm (50 units.)	Ref. 100187-02
Short Brown (50 units.)	Ref. 100185
Long Brown (50 units.)	Ref. 100186

Supplied in bags of 50 pcs.

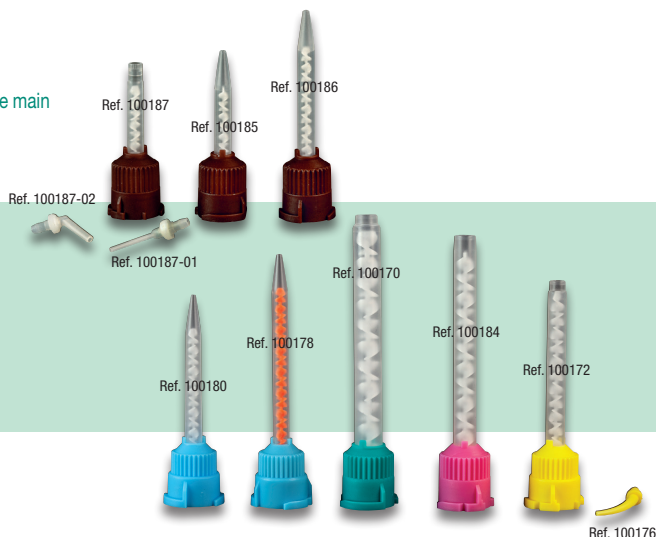

## Silicone pistol (reinforced)

Ref. 100166



(L) 190 x (W) 120 x (H) 70 mm 0,220 kg

## Disposable trays (100 units) Ref. 100219



Hygienic and disposable trays. They save time and detergent because they cut out cleaning operations. They are adjusted to the specific dimensions of each patient by applying heat. Transparent, so they can be used in implantology. Available in 10 different shapes and sizes.

Complete kit Ref. 100219

### Contents of the box:

- 10 units. UL - UM - US - P1
- 10 units. LL - LM - LS - P2
- 10 units. PB - PA

Replacement: 25 units of the ordered model

Upper large	Ref. 100220-UL
Upper medium	Ref. 100220-UM
Upper small	Ref. 100220-US
Lower large	Ref. 100220-LL
Lower medium	Ref. 100220-LM
Lower small	Ref. 100220-LS
Partial A	Ref. 100220-PA
Partial B	Ref. 100220-PB
Lower (kid)	Ref. 100220-P1
Upper (kid)	Ref. 100220-P2

### DIMENSIONS

(L) 380 x (W) 290 x (H) 130 mm Paking (100 u.) 1,526 kg

### REPOSICIONS

(L) 200 x (W) 200 x (H) 80 mm Paking (25 u.) 0,246 kg

## Disposable trays (100 units) with retention Ref. 100222



Made of a very resistant plastic, and therefore rigid and non-deformable. Thanks to their anatomic design and to the different sizes and shapes available (10 options) they can be easily adaptable to any patient. They feature inner retention to prevent unwanted movements of the alginate. Besides, their base has several cuts so that -if necessary- windows can be easily opened with a drill, thus avoiding the implant posts.



Complete kit Ref. 100222

### Contents of the box:

- 10 units. UL1 - UM3 - US5
- 10 units. LL2 - LM4 - LS6
- 10 units. Q7 - Q8
- 10 units. UA9 - LA10

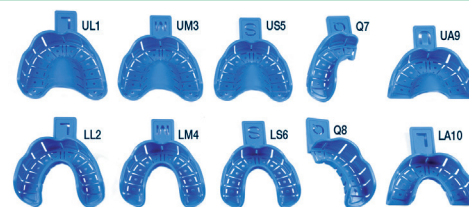

Replacement: 25 units of the ordered model

Upper large	Ref. 100222-UL1
Upper medium	Ref. 100222-UM3
Upper small	Ref. 100222-US5
Lower large	Ref. 100222-LL2
Lower medium	Ref. 100222-LM4
Lower small	Ref. 100222-LS6
Partial 7	Ref. 100222-Q7
Partial 8	Ref. 100222-Q8
Lower front	Ref. 100222-UA9
Upper front	Ref. 100222-LA10

### DIMENSIONS

(L) 380 x (W) 290 x (H) 130 mm 1,526 kg

## Impression trays (with retention)

Stainless steel

Ref. 070450 Set of 6 trays



Ref. 070452 = L2	0,047 kg	Ref. 070457 = U2	0,055 kg
Ref. 070453 = L3	0,048 kg	Ref. 070458 = U3	0,052 kg
Ref. 070454 = L4	0,043 kg	Ref. 070459 = U4	0,049 kg

## Hand magnifying glass with light

Ref. 100092



Supplied with 4 set of lenses:  
1.5x, 2.0x, 2.5x and 3.5x magnification

Ref. 100092	(L) 190 x (W) 100 x (H) 40 mm	0,18 kg
-------------	-------------------------------	---------

## Magnifying glass with base

Ref. 100098

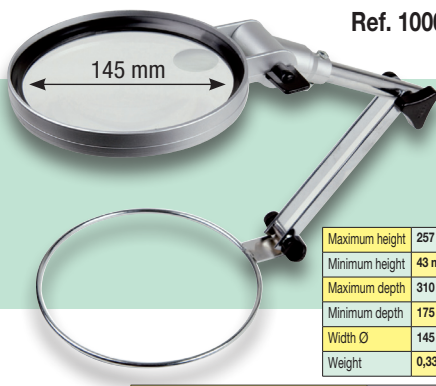

Maximum height	257 mm
Minimum height	43 mm
Maximum depth	310 mm
Minimum depth	175 mm
Width Ø	145 mm
Weight	0,330 kg

Ref. 100098	(L) 315 x (W) 154 x (H) 45 mm	0,43 kg
-------------	-------------------------------	---------

## Hand magnifying glass with light

Ref. 100099



Length	65 mm
Length unfolded	103 mm
Width	40 mm
Weight	0,055 kg

Ref. 100099	(L) 70 x (W) 50 x (H) 30 mm	0,06 kg
-------------	-----------------------------	---------

## Holding clamps

Ref. 050554

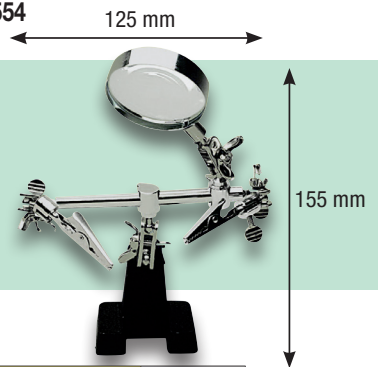

Ref. 050554	(L) 120 x (W) 75 x (H) 68 mm	0,4 kg
-------------	------------------------------	--------

## UV-ray safety screen

Ref. 070515

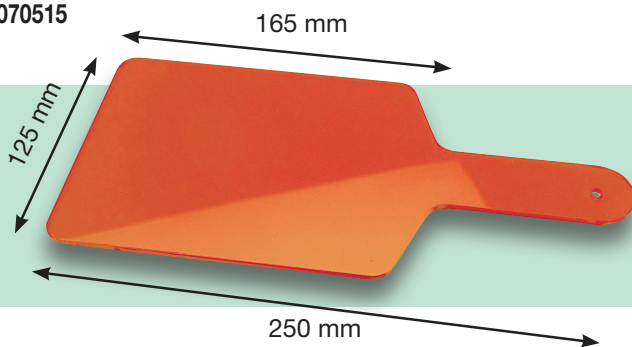

Ref. 070515	(L) 255 x (W) 125 x (H) 4 mm	0,09 kg
-------------	------------------------------	---------

## Safety glasses

Ref. 100014

U.V.

Ref. 100013



Ref. 100011-12-13	(L) 160 x (W) 54 x (H) 56 mm	0,05 kg
-------------------	------------------------------	---------

Ref. 100014	(L) 180 x (W) 90 x (H) 65 mm	0,07 kg
-------------	------------------------------	---------

## Face protection (10 units)

Ref. 100021



Ref. 100021	(L) 285 x (W) 185 x (H) 35 mm	0,23 kg
-------------	-------------------------------	---------

## Face protection (10 units)

Ref. 100022



Ref. 100022	(L) 308 x (W) 215 x (H) 35 mm	0,28 kg
-------------	-------------------------------	---------



## Magnifying glasses



Adjustable system that adapts to the head and keeps the hands free to work. It has Ultra clear lens of minimal light absorption. It can be worn over glasses. There are three different models available:

Ref. 100079		(L) 285 x (W) 225 x (H) 89 mm		0,545 kg
Ref. 100080		(L) 205 x (W) 185 x (H) 70 mm		0,245 kg
Ref. 100090		(L) 175 x (W) 175 x (H) 70 mm		0,195 kg

## Binocular magnifying glass



2,5 magnification.  
420 mm working distance.

R - 100096		(L) 215 x (W) 145 x (H) 75 mm		0,328 kg
------------	--	-------------------------------	--	----------

## Dial crown thickness caliper

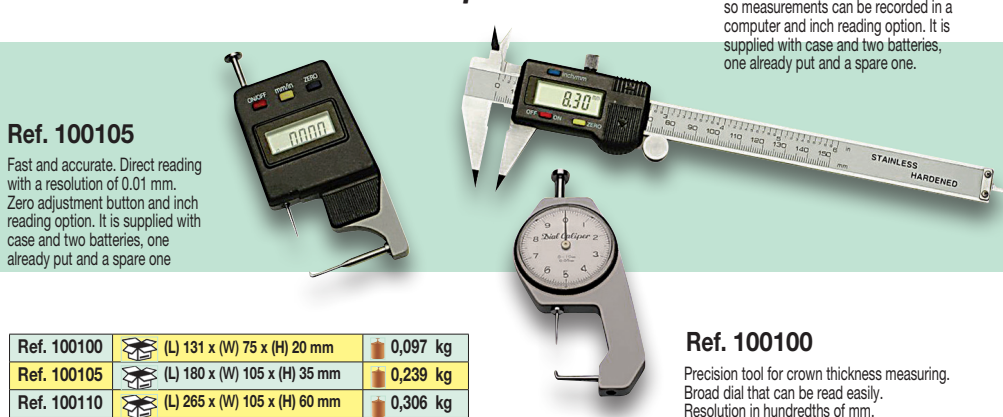

**Ref. 100105**  
Fast and accurate. Direct reading with a resolution of 0.01 mm. Zero adjustment button and inch reading option. It is supplied with case and two batteries, one already put and a spare one

**Ref. 100110** Essential for laboratory and dental clinic works. Zero adjustment button, out bus so measurements can be recorded in a computer and inch reading option. It is supplied with case and two batteries, one already put and a spare one.

Ref. 100100		(L) 131 x (W) 75 x (H) 20 mm		0,097 kg
Ref. 100105		(L) 180 x (W) 105 x (H) 35 mm		0,239 kg
Ref. 100110		(L) 265 x (W) 105 x (H) 60 mm		0,306 kg

**Ref. 100100**  
Precision tool for crown thickness measuring. Broad dial that can be read easily. Resolution in hundredths of mm. It is supplied in a practical case.

## Microscope with base

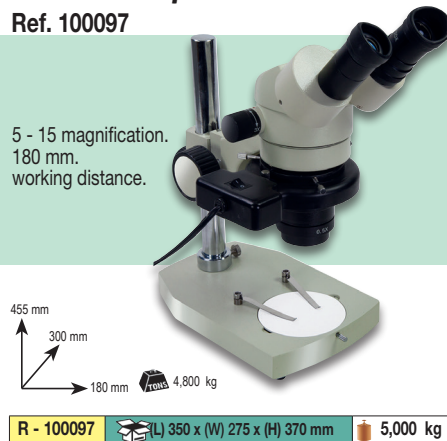

5 - 15 magnification.  
180 mm. working distance.

R - 100097		(L) 350 x (W) 275 x (H) 370 mm		5,000 kg
------------	--	--------------------------------	--	----------

## Manual developer

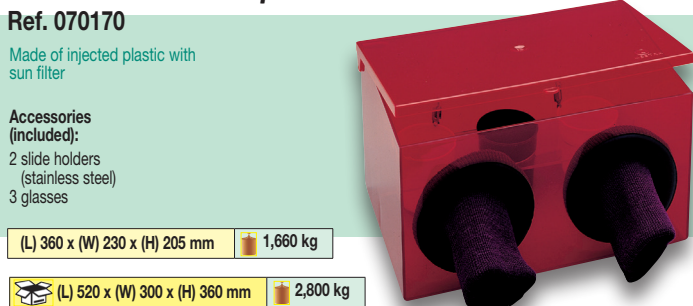

Made of injected plastic with sun filter

Accessories (included):  
2 slide holders (stainless steel)  
3 glasses

(L) 360 x (W) 230 x (H) 205 mm		1,660 kg	
	(L) 520 x (W) 300 x (H) 360 mm		2,800 kg

## Manual developer



(With negatoscope) Ref. 070180

(L) 360 x (W) 230 x (H) 270 mm		3,500 kg	
	(L) 520 x (W) 300 x (H) 360 mm		4,700 kg

## Dental film clip (4 units)

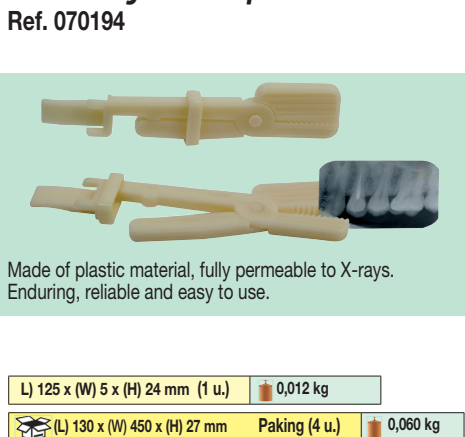

Made of plastic material, fully permeable to X-rays. Enduring, reliable and easy to use.

(L) 125 x (W) 5 x (H) 24 mm (1 u.)		0,012 kg	
	(L) 130 x (W) 450 x (H) 27 mm Paking (4 u.)		0,060 kg

## Dental film clip (12 units)



(L) 38 x (W) 12 x (H) 8 mm (1 u.)		0,002 kg	
	(L) 70 x (W) 50 x (H) 16 mm Paking (12 u.)		0,017 kg

## Holder for



It simplifies the operation and handling of up to 10 dental films. Completely made in stainless steel.

(L) 205 x (W) 65 x (H) 22 mm		0,065 kg
------------------------------	--	----------

## X-ray viewers (flat)

DIMENSIONS	Vision area:	Outer area		
Ref. 100131 DIN A4	300 x 210 mm.	360 x 240 x 20 mm.	Wall and tabletop	1,700 kg
Ref. 100132 SRA3	430 x 355 mm.	510 x 495 x 23 mm.	Wall and tabletop	3,076 kg
Ref. 100134 DIN A2	580 x 400 mm.	700 x 520 x 33 mm.	Wall	4,000 kg

X-ray viewers with a high brightness (3500 Lux) cold-light screen. This technology also features a low power consumption and a practically unlimited duration (10000 hours minimum).

Model **Ref. 100132** has a large SRA3-size LED-backlit screen on which large-format films can be viewed. It also has light intensity regulation and two types of operation: automatic, when the film approaches the device turns on without pressing the button; switched on by pressing the button.



## X-ray viewer Ref. 070460

Supplied with 30° inclined tripod.  
Can also be placed horizontally or screwed to the wall.  
Includes a system of springs by which the cover can hold the plates.  
Size 400 x 200 mm.



### DIMENSIONS

(L) 410 x (W) 200 x (H) 88 mm	4,032 kg
(L) 515 x (W) 350 x (H) 290 mm	4,500 kg

## Dose measuring spoon

Ref. 100270

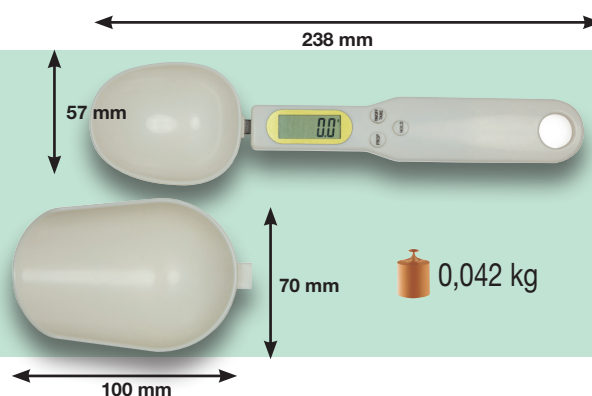

PROVEN: save 20-40% on plaster

## Precision scale

### Ref. 100041

0.1 g resolution, maximum load of 3000 g, and "piece counting" function, very useful to count small elements such as pins, etc.

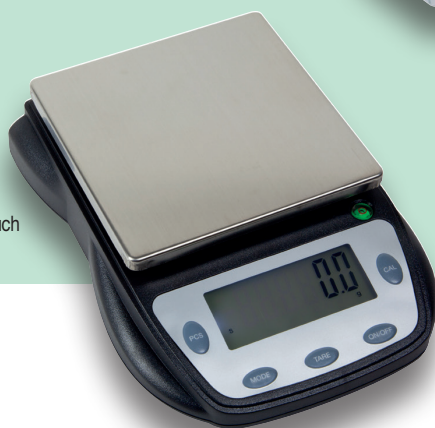

### Ref. 100040

0.05 g resolution in the weight rank of 0-1000 g, and 0.1 g in the rank of 1000-2000 g.



### Ref. 100042

Precise resolution of 0.1 g and high weighing capacity (1000 g).

Ref. 100040	(L) 150 x (W) 110 x (H) 36 mm	0,286 kg
Ref. 100041	(L) 248 x (W) 248 x (H) 100 mm	0,774 kg
Ref. 100042	(L) 300 x (W) 190 x (H) 55 mm	0,446 kg

## Mulhacén Trimmers



Ref. 080093



Ref. 080095

Warning light

### Mulhacén model trimmers Ref. 080093 Ref. 080095 *Diamant*

Modern and versatile model trimmer. It features a powerful 1600 W motor with integrated brake, opening lid for easy access to the disc, operation warning light, discs with hook-and-loop type (Velcro®) fastener, sophisticated cleaning system, adjustable worktable... and an endless list of elements which make it –probably– the most complete model trimmer in the market. Unbeatable quality/price ratio.

## Mulhacén model trimmer DRY



### Mulhacén model trimmer DRY Ref. 080096

The main characteristic of the trimmer is that the surfacing operation is performed dry.  
-Stability of the material to be trimmed, since it is not wet.  
-Higher performance and longer life, minimal effort.

OPTIONAL EXHAUSTER (ESSENTIAL).

OPCIONAL:

Ref. 080539

Ref. 080538



- Hook-and-loop (velcro®) type abrasive disc. High cutting power and very easy to replace.

(L) 400 x (W) 530 x (H) 440 mm 13,500 kg



Conforms to UL Std. 61010-1.  
Cert. to CSA-22.2 No. 61010-1-12.



- Easily removable cover (wide-opening hinge). Easy to clean and easy access to the disc.
- Made of very strong technical plastics.
- Corrosion free

## Accessories

- 1 Ref. 080093-04 (5 u.) 80 grit abrasive disc (coarse)
- 2 Ref. 080093-05 (5 u.) 120 grit abrasive disc (fine)
- 3 Ref. 080093-55 (1 u.) Diamond disc
- 4 Ref. 080093-65 (1 u.) Silicon carbide disc Ø 250 mm



### CAUTION!

Diamond discs are very heat-sensitive: do not trim or rectify metal pieces or coatings.

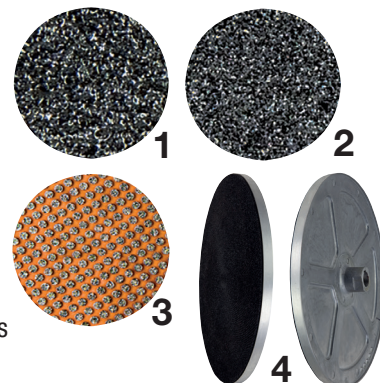

**NEW**



## Serantes model trimmer

*Sandpaper disc trimmer*

**Ref. 080097**

*Diamant disc trimmer*

**Ref. 080098**

*Sandpaper disc - DRY trimmer*

**Ref. 080099**



**Ref. 080097**



**Ref. 080098**



**Ref. 080099**

Ultra compact. It may be the trimmer currently on the dental market, with smaller dimensions. The concept of him derives directly of the **Mulhacén model (080093)**, with which it shares many of its performance and characteristics, except for dimensions. In this sense we can speak of a powerful 1600 W motor with integrated brake, lid with easy opening to access the disc, discs with easily changeable hook / loop type fixation, water cleaning system, high resistance composite manufacturing and of course no corrosion, etc.

Ideal for general dental applications and especially for those environments in which the user does not have much space, but who nevertheless does not want to give up the possibilities that a completely professional trimmer offers in terms of productivity and quality: the size of the table and window have been studied so that it can be used in jobs similar to those carried out on larger trimmer models.

The Serantes trimmer is supplied in three different versions, all of them with a hook/loop disc fixing system:

- With a choice of conventional 80 or 120 grain abrasive disc. General purpose version ideal for any dental user.
- With diamond disc: Designed for demanding environments in those that speed and productivity are key aspects.
- Dry, without water circuit: Designed for environments where the water supply and drainage are difficult to install or for professionals who do not want to wet the models.

Serantes is fully compatible with the MESTRA range of decanters. Supplied with 2 sandpaper discs.

### SPECIFICATIONS

Voltage	230 V - 50-60 Hz
Rated power	1600 W
Disc diameter	235 mm
Speed	3000 rpm
Dimensions	(L) 385 x (W) 285 x (H) 332 mm
Weight	10,2 kg

## Accesorios

- 1 Ref. 080097-08 (5 u.) Sandpaper disc coarse grain - 80
- 2 Ref. 080097-09 (5 u.) Sandpaper disc fine grain - 120
- 3 Ref. 080098-01 (1 u.) Diamant disc

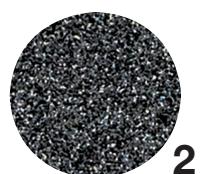
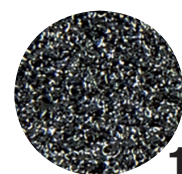



## CLASIC Trimmers



Ref. 080082



Ref. 080083

 (L) 330 x (W) 570 x (H) 400 mm  24,000 kg

### 3000 rpm. Trimmer (silicon carbide disc) Ref. 080082

It is the model that best meets the requirements of the dental lab. Its trimming power is very high, and it can cope with a heavy workload in a very short time. Recommended for experienced professionals working in places where a little more noise or splashing is not a problem.

### Diamond disc trimmer Ref. 080083

Identical features of the previous model, but with a diamond disc.



Ref. 080080



Ref. 080081

### 1500 rpm. Trimmer (silicon carbide disc) Ref. 080080

Due to its low speed, the main advantage of the trimmer is its easy handling, its silent operation and the scarce splashing it produces. Thus, it is recommended for professionals not very familiarized with trimming who work in places that have to remain clean or in places where they cannot make too much noise.

### Diamond disc trimmer Ref. 080081

Similar features of the previous trimmer, but with a diamond disc. The diamond disc, if used properly, has a much longer working life. Besides, the trimming surface is maintained completely flat, with no wear scratches. Its price, however, is higher.

## Model trimmer CLASIC DRY



### RDS-1 trimmer Ref. 080084 DRY

The main characteristic of the RDS-1 trimmer is that the surfacing operation is performed dry, with a diamond disc at 1.500 r.p.m.  
-Stability of the material to be trimmed, since it is not wet.  
-Higher performance and longer life, minimal effort.  
OPTIONAL EXHAUSTER (ESSENTIAL).

**Silicon carbide disc** Ø 250 mm

Ref. 080080-03

**Diamond disc** Ø 254 mm

Ref. 080081-01

**All diamond disc** Ø 254 mm

Ref. 080079-05

### CAUTION!

Diamond discs are very heat-sensitive: do not trim or rectify metal pieces or coatings.

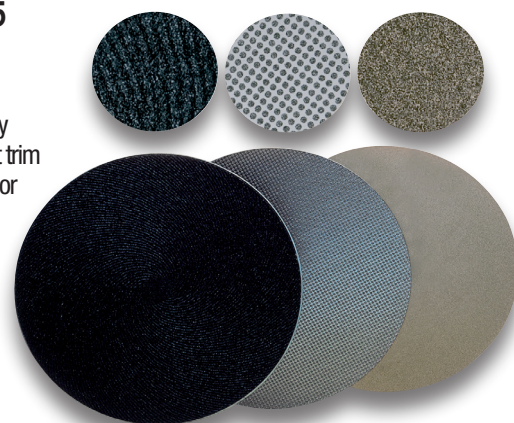

## Decanter (19 l.)

Ref. 080085

Made of resistant polypropylene. It has been specifically designed for a quick and easy cleaning, since dirt is collected in a plastic bag. The lid closes hermetically and prevents the spread of bad smells. Its size and shape have been designed for the unit to be easily installed under the sink.



(Ref. 080085-02)  
20 unit bags



Height	465 mm
Diameter	400 mm
Capacity	19 l.
Weight	3.2 kg

(L) 500 x (W) 430 x (H) 430 mm	4.5 kg
--------------------------------	--------

## Decanter (14 l.)

Ref. 080087

Similar features to the Ref. 080085, but smaller (14 l.)



(Ref. 080085-02)  
20 unit bags



Height	345 mm
Diameter	350 mm
Capacity	14 l.
Weight	2.2 kg

(L) 360 x (W) 360 x (H) 340 mm	2.8 kg
--------------------------------	--------

## Decanter (18 l.)

Ref. 080086

-Made of stainless steel  
-With plastic lid to prevent smells

Inox



Height	290 mm
Diameter	450 mm
Capacity	230 mm
Weight	6.5 kg

(L) 520 x (W) 300 x (H) 350 mm	7.5 kg
--------------------------------	--------

## Decanter (70 l.)

Ref. 080089

It is made in highly resistant fibreglass with a total capacity of 70 l. and a design that allows an easy installation under the sink. It also has wheels which make its movement easier. Cleaning and emptying operations are easy because of the optimum access to the cube. This machine is supplied with all the couple nuts and accessories for its installation.



Height	615 mm
Diameter	520 mm
Capacity	600 mm
Weight	10 kg

(L) 650 x (W) 650 x (H) 650 mm	15 kg
--------------------------------	-------

## Round electrovibrator Ref. 080030

Its body is made of white colour anodized aluminium, and rests on suction pads. The working surface is made of rubber on a metal body and has a recess of 30 mm for inserting the tray. It is equipped with a potentiometer, a selector switch (+,-) for stepped adjustment of vibrations, and an "ON" light.



DIMENSIONS

(L) 152 x (W) 152 x (H) 100 mm	2.5 kg
Working area	120 mm

(L) 310 x (W) 310 x (H) 190 mm	3 kg
--------------------------------	------

## Round electrovibrator (small) Ref. 100200

Strong and reliable vibrator at an outstanding price. 4-position power control.



DIMENSIONS

(L) 127 x (W) 127 x (H) 90 mm	1.6 kg
Working area	125 mm

(L) 200 x (W) 160 x (H) 90 mm	2 kg
-------------------------------	------

## Gorbea Polishing Mini Box

Ref. 080508



- Connection to aspiration.
- LED lamps.
- Protective shields.
- Safe switch.

• Brushes not included.

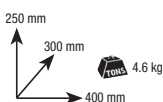

(L) 530 x (W) 400 x (H) 450 mm	5.6 kg
--------------------------------	--------

## Mini polisher

(Variable speed) Ref. 080164

- Brushes not included.



• ACCESSORY:

Ref. 100277-01 Ref. 100277-02

SPECIFICATIONS

Voltage	230 V 50-60 Hz
Power	200 W
RPM	2000-7000



(L) 300 x (W) 300 x (H) 200 mm	3.2 kg
--------------------------------	--------

## Plutón Sandblaster

stainless steel 2 Tanks Ref. 080253

Inox

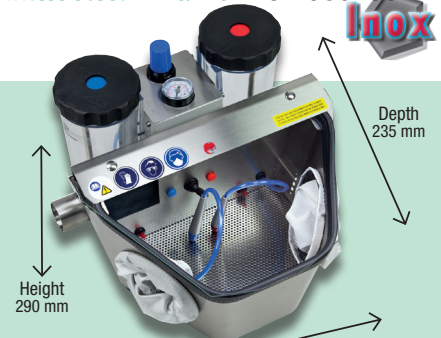

Protective covering (10 u.)  
Ref. 080253-50

Operating pressure	2 a 5 bars
Maximum air consumption	80 l. /min.
Voltage	230 V 50-60 Hz
Consumption	20 W

- 2 Mobile guns
- 1 Pedal
- LED lamps

(L) 490 x (W) 475 x (H) 490 mm	9.5 kg
--------------------------------	--------

7 kg

## Eclipse II Sandblaster

2 Tanks Ref. 080220

Cabin entirely made of ABS of reduced dimensions maintaining the amplitude in the work area and with a substantial improvement in lighting. They have two mobile micro-blasting nozzles and, in the hopper version, a large sand tank and a 3 mm static gun. Interior light LED.

Height	330 mm
Width	360 mm
Depth	450 mm
Weight	5.7 kg
Air cons.	80 l/min
Pressure	2 a 5 atm



## Finishing box Eclipse

Ref. 080216

- High luminosity LED lamp.
- Absence of shadows inside.
- Ergonomic work position.
- Optimal absorption of powder by means of external suction (not included).
- Easy cleaning.

Height	275 mm
Width	360 mm
Depth	330 mm
Weight	3.8 kg



## Work box Orión

Ref. 080214

- High luminosity LED lamp.
- Absence of shadows inside.
- Ergonomic work position.
- Optimal absorption of powder by means of external suction (not included).
- Includes a wedge in the interior with support for micromotor.
- Easy cleaning.

Height	300 mm
Width	360 mm
Depth	330 mm
Weight	3.3 kg



## Microblasting unit

(Lab) Ref. 100122



They are essential when cleaning and degreasing microretentions, crowns, "Inlay-Onlay"; occlusal sandblasting, adjustment of interproximal contacts and a great many other precise sandblasting operations.

Oxide	50 / 100 microns
Pressure	4 a 5.5 kgf/cm <sup>2</sup>
(L) 195 x (W) 110 x (H) 45 mm	0.3 kg

## Eolo Induction aspiration unit Ref. 080533

Its new "brushless" induction motor extends its useful life between 5 and 10 times compared to traditional models, and has an innovative double filter system optimized for work in the dental clinic (including abrasives such as rust aluminum). It can be mounted with HEPA filter.

The electronic control with LCD screen is equipped with protection systems against overloads or obstructions in the suction mouth and with a visual indicator of the filter filling level and the detection of the micromotors. It allows manual or automatic operation synchronized with up to 3 different devices (sandblasters, micromotors, etc.).

The detection and adjustment of micromotors is carried out by the electronic control itself, which allows detecting any micromotor, including those of the "brushless" type.



(L) 550 x (W) 320 x (H) 620 mm	20 kg
--------------------------------	-------

Height	585 mm
Width	210 mm
Depth	500 mm
Weight	17 kg
Power	750 W
Noise	65 dB

## Ciclón dust decanter

Ref. 080535

It is a simple device to be connected to the inlet pipe of a conventional Aspiration Unit for pre-filtering dust particles. The air circulates along a circuit that makes the dust particles fall into an inner tank. More than 99% of the aspirated dust and dirt is removed, reducing the risk of obstruction of the aspiration pipes and making the working life of the aspiration filters considerably longer. The dust tank is easily accessible and, therefore, cleaning the device is a comfortable and simple task. The device features anchoring elements especially adapted to MESTRA's EOLO aspiration, with which it makes up a high performance compact unit.

CICLÓN is built in high resistance polypropylene.

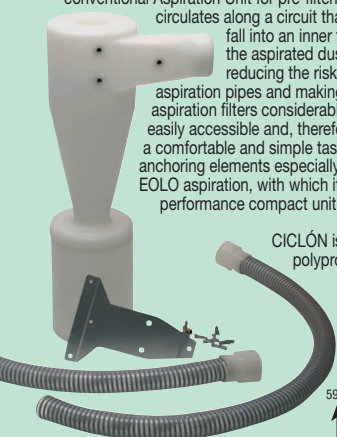

590 mm	275 mm
155 mm	2 kg

(L) 520 x (W) 300 x (H) 360 mm	3 kg
--------------------------------	------

## Gemini aspiration unit

Ref. 080539

Voltage	230 V
Power	1200 W (2 steps)
Noise	68 dB
Capacity	36 l
Potentiometer	650-1200 W
Detection from	100 W
Aspiration	Solids & liquids

\*Unsuitable for micro-motors



633 mm	433 mm
406 mm	10.4 kg

(L) 480 x (W) 450 x (H) 710 mm	14 kg
--------------------------------	-------

## Gemini mini aspiration unit

Ref. 080538

For use in locations with reduced space.

Voltage	230 V
Power	1150 W
Noise	68 dB
Capacity	9.5 l
Potentiometer	650-1150 W
Detection from	100 W
Aspiration	Solids & liquids

\*Unsuitable for micro-motors



390 mm	350 mm
350 mm	7.3 kg

(L) 370 x (W) 360 x (H) 530mm	9 kg
-------------------------------	------



## Sirocco suction units

It is difficult to find a manufacturer in the dental sector that offers such a wide range of professional suction units as the Sirocco family, covering any possible need that may arise with the most suitable model for each case.

In addition, the modular and scalable nature of this range provides solutions for both clinical and laboratory use, allowing the user to choose from a multitude of options, such as unit size, arm type, filtering system, etc.

Although the number of alternatives and accessories is enormous, all units follow the same script: they are extremely quiet, aesthetically appealing suction units incorporating powerful induction motors (with a longer life than traditional models) and very economical consumables, with the level of quality that MESTRA guarantees in all of its products.



Induction motor (brushless)



Efficient low-noise suction (55 dB)



Strong suction power



Easy removal and cleaning of the reusable filters

## Sirocco S Ref. 080534

Suction especially suitable for clinical and laboratory environments, it is the perfect size for desktop use and has a sleek aesthetic.

The Sirocco S model incorporates two stages of filtration: a first circular HEPA (High Efficiency Particulate Array) filter and a second internal HEPA filter. Thanks to its efficient design, the filter change operation is extremely simple.

The unit also features an external micromotor detection system and seven different power levels.

- Powerful induction motor
- Intuitive "touch" keypad
- Easy to use and change filter
- Exceptionally quiet

### SIROCCO S TECHNICAL CHARACTERISTICS

Height	135 mm	Weight	3.1 kg
Width	280 mm	Power	350 W
Depth	280 mm	Noise	55 dB



Ref. 080534AT

Basic configuration of the Sirocco Model S table-top suction unit, supplied with a flexible and extendable hose up to 700 mm for directing the suction to the work area. It allows small and delicate polishing and reworking operations.

- Easy to orient the suction hood
- Built-in LED lighting

Tube 700 mm • Ø 45 mm • Weight 3.8 kg

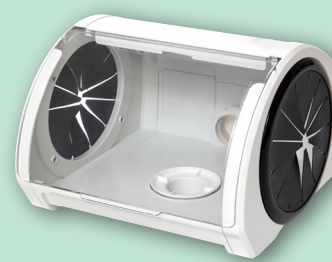

230 mm  
290 mm  
290 mm  
Clinic finishing box  
Ref. 080534C  
2.4 kg



230 mm  
400 mm  
345 mm  
Laboratory finishing box  
Ref. 080534L  
2.4 kg



Ref. 080534AC

Sirocco S and finishing box for clinics. Together they form an extremely useful and reliable partnership for a clinic environment, allowing for minor polishing and reworking operations.

- Large screen and access
- LED lamp for perfect illumination
- Great working ergonomics

Height 365 mm • Width 290 mm  
Depth 290 mm • Weight 5.5 kg

## Large finishing box

Ref. 080212

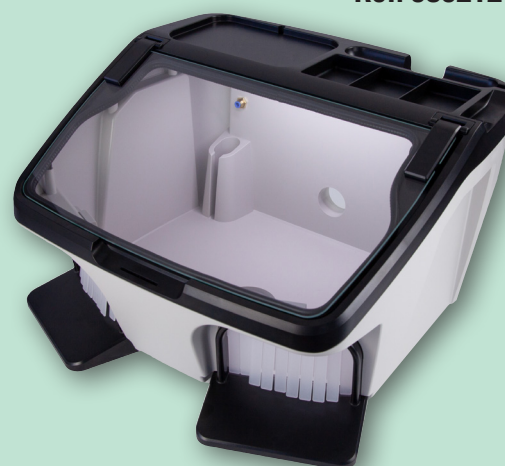

542 mm  
336 mm  
500 mm  
4.9 kg

- Spacious and robust design
- Large screen and access
- LED lamp for perfect illumination
- Great working ergonomics
- Comfortable and practical armrests

Sirocco S suction unit and a dental laboratory finishing box that is fully compatible with the benchtop unit, forming a very compact and balanced unit.

- Spacious and robust design
- LED lamp for perfect illumination
- Comfortable and practical armrests

Height 365 mm • Width 345 mm  
Depth 400 mm • Weight 5.5 kg

Finishing box that is fully compatible with the Sirocco M and L suction units with which it forms an extremely useful and reliable tandem for a clinic and laboratory environment, allowing small polishing and refinishing operations.

Ref. 080534AL



## Sirocco M y L Ref. 080536 - Ref. 080537

These are two robust, quiet and highly reliable suction units, the M model being particularly practical for use under the workbench and the larger capacity L model very useful in CAD/CAM suction systems.

Its brushless motor extends its service life by five to ten times compared to traditional models.

They incorporate a connection for an external micromotor and a milling machine that will operate synchronously with the suction unit. In addition, its ergonomic design with handles and wheels facilitates its use and mobility in the clinic and laboratory.

Depending on requirements, you can choose to use disposable bag filters or reusable HEPA1 filters, or even a ULPA2 filter, as well as three different arm types; flexible hose for connection to other devices, swivelling snake arm or articulated arm, which are also equipped with different suction hoods.

- Extensive set of fully compatible accessories
- Exceptionally quiet operation
- Easy to use and change filter



Sirocco M with flexible hose  
**Ref. 080536A** (small disposable filter)  
**Ref. 080536D1** (reusable filter 4.3 l)  
**Ref. 080536D2** (reusable filter 2.5 l)



Sirocco M with articulated arm  
**Ref. 080536C** (small disposable filter)  
**Ref. 080536F1** (reusable filter 4.3 l)  
**Ref. 080536F2** (reusable filter 2.5 l)



Sirocco M with snake arm  
**Ref. 080536B** (small disposable filter)  
**Ref. 080536E1** (reusable filter 4.3 l)  
**Ref. 080536E2** (reusable filter 2.5 l)

### SIROCCO M TECHNICAL CHARACTERISTICS

Height	580 mm
Width	290 mm
Depth	330 mm
Weight	11 kg
Power	800 W
Noise	55 dB
CAM Cable Interface	
Filtration grade ULPA U15	



Sirocco L with flexible hose  
**Ref. 080537A** (large disposable filter)  
**Ref. 080537D** (reusable filter 7.5 l)



Sirocco L with articulated arm  
**Ref. 080537C** (large disposable filter)  
**Ref. 080537F** (reusable filter 7.5 l)



Sirocco L with snake arm  
**Ref. 080537B** (large disposable filter)  
**Ref. 080537E** (reusable filter 7.5 l)

### SIROCCO L TECHNICAL CHARACTERISTICS

Height	800 mm
Width	290 mm
Depth	330 mm
Weight	13 kg
Power	800 W
Noise	55 dB
CAM Cable Interface	
Filtration grade ULPA U15	

## Alginate mixer Ref. 080515



Ref. 080515-02

Bowl	750 cc
Diameter	130 mm
Height	110 mm
Weight	0.2 kg

CE Medical Device  
MDR 2017/745

Useful tool when making alginate paste in the dental clinic. Its operation is easy: just place powder and water in the bowl and select the rotation speed (fast/slow) by pressing the button. While rotating, the user can mix the paste with a spatula till it reaches the appropriate consistency and texture.

The user can control visually the process at every stage, and this guarantees that the paste made is in optimal conditions for application. In order to make cleaning easier the bowl is detachable. It is factory supplied with a bowl and a special plastic spatula.

Height with bowl	230 mm
Width	175 mm
Depth	250 mm
Weight	3 kg
Power	60 W

(L) 300 x (W) 310 x (H) 195 mm 3.9 kg

## Automatic mixing alginate Ref. 100191

Just fill the bowl with alginate and water, put it into the machine, press the button, and in a few seconds you will achieve a completely homogeneous mixture, ready for use.

Silent, small, comfortable and above all economical and reliable. Factory supplied with a bowl set, a plastic spatula and a practical water dispenser. It can also be used as plaster mixer with astonishing results.

● **MAXIMUM MIXTURE**  
80 grs. Alginate + water



The machine is factory supplied with four bowls, a practical water dispenser, a mixing stick, a spatula and a holder.



Height	305 mm
Width	205 mm
Depth	265 mm
Weight	17 kg
Voltage	230 V 50/60 Hz
Power	350 W

(L) 300 x (W) 420 x (H) 430 mm 18.5 kg

## Tight tank for alginate Ref. 100189



Height	190 mm
Width	150 mm
Depth	220 mm
Weight	0.5 kg
Capacity	1 kg

(L) 220 x (W) 155 x (H) 200 mm 0.6 kg

Suitable for 99% of silicones



## Silicone mixer Ref. 100360

Impression material mixer simple, fast, reliable and safe.

With small size to be located anywhere in the laboratory.

The cartridge insertion / removal operation is easily performed within a few seconds.

The mixer has three adjustable pouring speeds to cover the needs of each job.

Its amazing sturdiness together with the power of its motors generate a totally fluid mass, with optimum viscosity and totally free of bubbles without any effort.

All this means reduction of time, material and the improvement of the quality of the works.

Compatible with almost cartridges type 380 ml present in the market.

Height	290 mm
Width	170 mm
Length	250+150 mm
Weight	7.1 kg
Temp. environment	5-40 °C
Supply	240 V 50 Hz
Power	150 W
Push	450 kg +-10



## Vacuum forming machine Ref. 080542

It is cheap, easy to use and has an attractive design. It has a powerful aspiration motor with automatic connection when the sheet holder goes down. The carbon heater allows a progressive and uniform heating of the material that is going to be formed. It can be used with square sheets. Is supplied with a plane model holder and with a basket that can be filled with grit (a can is included with the machine) so forming depth is reduced.

Sheets  $\square$  from 125 to 134 mm  
 Sheets  $\circ$  from 125 to 134 mm  
 (adapter available for  $\circ$  120, not included)

(L) 300 x (W) 270 x (H) 430 mm 6 kg

Height	310 mm	Weight	4.6 kg
Width	275 mm	Power	925 W
Depth	260 mm		

## Thermoforming sheets

Standard square thermoforming sheets of 127 x 127 mm.

Made of high quality plastic with FDA approval and CE marking certifications.

There is no soot, nor fumes during the heating. As they do not contain recycled materials, they do not tear while subjected to vacuum.

They are available in a wide range of thickness and types.

Ref.	Hardness	Thickness	Amount	Weight	$\square$ (L) x (W) x (H) mm
080563	Hard	0.5	50	0.6 kg	131 x 131 x 44 mm
080564	Hard	0.75	25	0.4 kg	131 x 131 x 34 mm
080565	Hard	1	25	0.6 kg	131 x 131 x 34 mm
080566	Hard	1.5	25	0.9 kg	131 x 131 x 44 mm
080567	Hard	2	12	0.5 kg	131 x 131 x 34 mm
080568	Soft	0.5	25	0.2 kg	131 x 131 x 15 mm
080569	Soft	1	12	0.2 kg	131 x 131 x 15 mm
080570	Soft	1.5	12	0.3 kg	131 x 131 x 34 mm
080571	Soft	2	12	0.4 kg	131 x 131 x 34 mm
080572	Bruxism	3	8	0.4 kg	131 x 131 x 34 mm
080573	Sports	4	6	0.4 kg	131 x 131 x 34 mm



## Pressure former PlastPress

Ref. 080544

The most compact positive pressure machine on the market. Greater accuracy in the forming process and lower noise compared to vacuum machines. Practical and versatile, it accepts round and square sheets up to 6 mm thickness. It must be connected directly to a compressor (between 3 and 8 bar).

Height	270 mm
Width	235 mm
Depth	265 mm
Weight	7.5 kg
Power	450 W

Sheets  $\square$  from 125 to 131 mm  
 Sheets  $\circ$  from 120 a 134 mm

## Thermoforming sheets

Standard square and round thermoforming sheets. Made of high quality plastic with CE marking certification as medical device. There is no soot, nor fumes during the heating. As they do not contain recycled materials, they do not tear while subjected to vacuum.

(L) 310 x (W) 270 x (H) 310 mm 8.5 kg

Ref.	Type	Hardness	Appearance	Size (mm)	Thickness	Qty.
080574	Crystal	Hard	Transparent	126x126	0.3 mm	10
080575	Crystal	Hard	Transparent	126x126	0.75 mm	5
080576	Crystal	Hard	Transparent	126x126	1.0 mm	5
080577	Crystal	Hard	Transparent	126x126	1.5 mm	5
080578	Crystal	Hard	Transparent	126x126	2.0 mm	5
080579	Milky	Hard	Translucent	126x126	0.6 mm	10
080580	Soft	Soft	Translucent	131x131	1.0 mm	10
080581	Soft	Soft	Translucent	131x131	1.5 mm	10
080582	Soft	Soft	Translucent	131x131	2.0 mm	10
080583	Soft	Soft	Translucent	131x131	3.0 mm	5
080584	Soft	Soft	Translucent	131x131	4.0 mm	5

Ref.	Type	Hardness	Appearance	Size (mm)	Thickness	Qty.
080574R	Crystal	Hard	Transparent	$\circ$ 125	0.3 mm	10
080575R	Crystal	Hard	Transparent	$\circ$ 125	0.75 mm	5
080576R	Crystal	Hard	Transparent	$\circ$ 125	1.0 mm	5
080577R	Crystal	Hard	Transparent	$\circ$ 125	1.5 mm	5
080578R	Crystal	Hard	Transparent	$\circ$ 125	2.0 mm	5
080579R	Milky	Hard	Translucent	$\circ$ 125	0.6 mm	10
080580R	Soft	Soft	Translucent	$\circ$ 125	1.0 mm	10
080581R	Soft	Soft	Translucent	$\circ$ 125	1.5 mm	10
080582R	Soft	Soft	Translucent	$\circ$ 125	2.0 mm	10
080583R	Soft	Soft	Translucent	$\circ$ 125	3.0 mm	5
080584R	Soft	Soft	Translucent	$\circ$ 125	4.0 mm	5



## Pressure former Ref. 080543

The strong pressurization allows precise molding, regardless of the cut of the model, as well as various thicknesses (0.5 to 4.0 mm). Square and round sheets (127, 125, 120 mm) can be used.

Height	545 mm
Width	410 mm
Depth	260 mm
Weight	15 kg
Power	450 W
Pressure	4-6 bar

## Drying oven Ref. 080118 for thermoforming sheets



- A fan circulates the hot air producing a uniform drying.
- Draws out moisture and keeps dry thermoforming sheets, to avoid the formation of pores.
  - Instrument drying.
  - Drying of plaster models, etc.
  - 6 stainless steel trays.
  - Stainless steel housing.
  - 24 hour timer.

Height	310 mm
Width	340 mm
Depth	450 mm
Weight	8.3 kg
Power	550-650 W
Temperature	35-75°C

## Water bath Ref. 080078

This machine is extremely useful when working with applications that need a water bath that keeps the water temperature accurately (polymerisation of small elements, wax sheets for biting registers, etc).

It has a 1 litre stainless steel tank and it is easy to clean.

The body is made in high density polyurethane, resistant to chemical agents.

Bath temperature control is made by an electronic thermostat easy to use and accurate when keeping the programmed temperature.

Temperature range is from 30°C to 75°C. A powerful heater allows reaching the set temperature in a few minutes.



### SPECIFICATIONS

Height	146 mm	Voltage	230 V
Width	230 mm	Temperature range	30-75 °C
Depth	195 mm	Power	310 W
Weight	1.7 kg	Capacity	1 l

	(L) 300 x (W) 300 x (H) 200 mm		2 kg
--	--------------------------------	--	------

## Micromotor (brushless) Black Ref. 100281

Strong torque at low speed. Vertical / horizontal placement. Right & Left turning ability. Hand / Foot speed control system. Self-diagnosis, error display, work memory storage function. Foot speed control.



Height	182 mm
Width	96 mm
Length	207 mm
Weight	3.9 kg
Speed	50000 rpm
Torque	7.8 N.cm
Power	230 W
Voltage	220-240 V - 50/60 hz

	(L) 280 x (W) 280 x (H) 200 mm		4.62 kg
--	--------------------------------	--	---------

## Élite Micromotor (brushless) Ref. 100285



- Brushless motor.
- Vertical/horizontal position.
- Left and right rotation.
- Hand/foot speed control.
- Self-diagnosis.
- Error display.



Height	182 mm	Speed	50000 rpm
Width	91 mm	Torque	7.8 N.cm
Length	205 mm	Power	230 W
Weight	2.5 kg	Voltage	230 V (50/60 Hz)

	(L) 280 x (W) 275 x (H) 200 mm		4.65 kg
--	--------------------------------	--	---------

## Knee Micromotor (brushless) Ref. 100278S

Brushless micromotor with foot or knee control. Right & Left turning ability. For Ø 2.35 mm burs, automatic speed maintenance function, overload protection and self-diagnosis.



Speed	50000 rpm
Torque	7.8 N.cm
Control box weight	3.1 kg
Hand piece weight	365 g

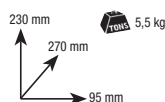

	(L) 260 x (W) 335 x (H) 215 mm		5 kg
--	--------------------------------	--	------

## Micromotor (brush) Ref. 100283

(Occasional use, not recommended for metals)

Connection for 2 handpieces. Right & left turning. Smooth manual/ pedal speed control. Automatic overload protection.

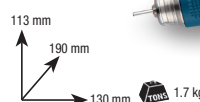
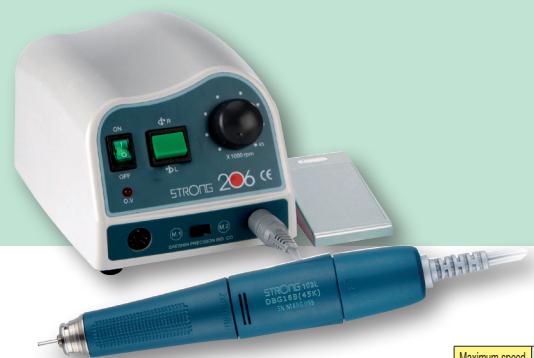

Maximum speed	45000 rpm
Torque	4.0 N.cm
Power	230 W

## Micromotor (brush) Ref. 100284

Occasional use, not recommended for metals  
Compact and ergonomic design.  
Choice of right-left spin.  
Automatic protection system against overload.  
Speed control pedal.

Max. speed	35000 rpm
Torque	2.94 N.cm
Power	45 W

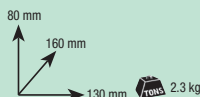

## Portable micromotors (10 h autonomy)

Ref. 100282  
(brushless) intramatic

L 210 x (W) 193 x (H) 73 mm	1.1 kg
-----------------------------	--------

RPM 30000  
Torque 250 gfcM  
Power 30 W

Occasional use,  
not recommended  
for metals

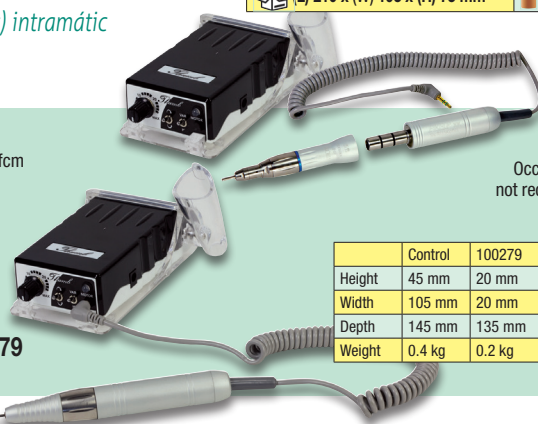

	Control	100279	100282
Height	45 mm	20 mm	20 mm
Width	105 mm	20 mm	20 mm
Depth	145 mm	135 mm	155 mm
Weight	0.4 kg	0.2 kg	0.2 kg

Ref. 100279  
(brush)

## Dry piston compressors

- 80 l/min compressor
- 80 l/min compressor with dryer
- 160 l/min compressor
- 160 l/min compressor with dryer

- Ref. 110300
- Ref. 110310
- Ref. 110330
- Ref. 110340

Family of four compressors consisting of two sizes of 80 and 160 litres/minute to which a dryer with automatic drain can be coupled.

Extremely quiet operation (60 dB), easy maintenance (dry piston) and excellent reliability. They are supplied with two pressure gauges (boiler and service pressure), outlet pressure regulator and complete set of valves for draining. The service pressure can reach 8 bars.



Ref. 110300



Ref. 110310



Ref. 110330

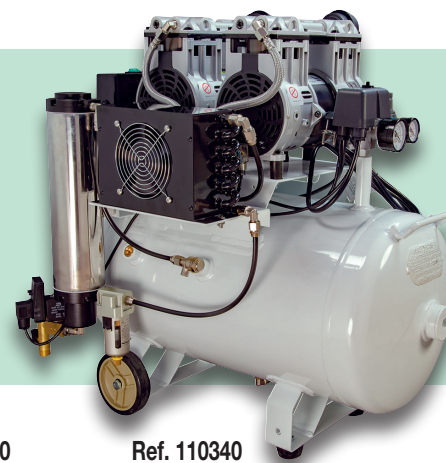

Ref. 110340

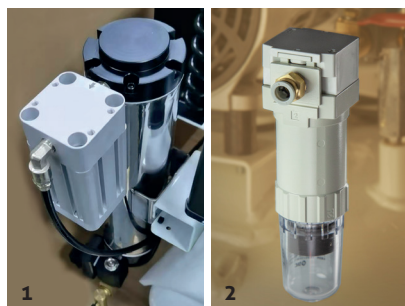

1. Ref. 110340 is also available with HEPA filter (H14)  
Ref. 110340H

2. The activated carbon filter Ref. 110300-53 is available as an accessory for all compressors.



### How do I know if my compressor complies with the European safety regulations?

It is easy to find dental compressors made in the East that do not comply with current European safety regulations. For this reason, it is advisable to check its features and security stamp: it is a plate welded to the tank similar to the attached picture. Next to the CE mark, you can see the number of the Notified Body that has validated its adaptation to European standards.



CERTIFICATE by TÜV SÜD Type certificate  
N° 12202200491258001  
Directive 2014/29/UE (pressure vessels)

Reference	110300	110310	110330	110340
Power	750 W	750 W	1500 W	1500 W
Effective airflow (4 bars)	80 l/min	80 l/min	160 l/min	160 l/min
Noise	53 dB	53 dB	54 dB	54 dB
Pressure	5-8 bar	5-8 bar	5-8 bar	5-8 bar
Tank capacity	30 l	30 l	50 l	50 l
Head number	1	1	2	2
Length	390 mm	540 mm	370 mm	480 mm
Width	390 mm	390 mm	680 mm	680 mm
Height	650 mm	650 mm	750 mm	750 mm
Weight	30 kg	37 kg	58 kg	66 kg

Weight	37 kg	44 kg	65 kg	73 kg
--------	-------	-------	-------	-------



## Wet ring suction unit Ref. 100345

Designed for a simple and reliable operation, the unit gives a quick response: it detects the start-up signal and reaches the optimum vacuum level in a record time. Its operation is extremely silent and it does not need any maintenance, since this technology automatically separates the air and the water with debris.

The suction power is always kept stable, with no noticeable ups and downs or failures. The unit is useful for intensive use workplaces, or for two workplaces in case of moderated use.

Height	585 mm
Width	405 mm
Depth	360 mm
Weight	27 kg
RPM	0-4000
Air flow	300 l/min
Power	750 W
Noise	58 dB

L 470 x (W) 430 x (H) 650 mm	25 kg
------------------------------	-------

## Calypso ultrasonic cleaner Ref. 080422

The "Calypso" model is a last generation Ultrasonic Cleaner that includes the latest innovations: Sandwich type transducers, with 100 W real power transmitted to the tank; working frequency of 40 KHz, representing an optimum compromise between sonority and cleaning power; electronic time control run by a microprocessor, with digital display and warning acoustic signals; automatic heating system of the cleaning liquid; high density polyurethane body, a material resistant to chemical agents; tank of 4 litre capacity and waste pipe; etc.

All these characteristics are complemented by an attractive line of careful design.

### The machine is supplied with the following accessories:

- A stainless steel basket for equipment cleaning.
- A glass for cleaning of little instruments and its support.
- A lid that eliminates the noise while working and prevents dirt coming into the cleaner.
- BuRef. cleaner tweezers (MESTRA Ref. 070520).



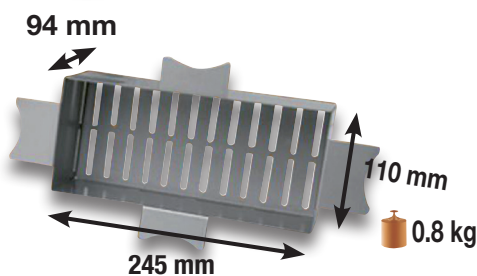

Ref. 080422-26 Optional Long basket (not included)



### SPECIFICATIONS

Height	220 mm
Width	425 mm
Depth	270 mm
Weight	4.5 kg
Tank capacity	4 l.
Voltage	230 V 50/60 Hz
Transducer power	100 W
Frequency	40 khz

 (L) 420 x (W) 360 x (H) 300 mm	 9 kg
--	--

## Ultrasonic bath 2.8 l

Ref. 100150



## Ultrasonic bath 5.8 l

Ref. 100152



Made of stainless steel: high resistance to wear and tear and long service life. Easy-to-use digital time control. It has a drain on the side. Time from 1 to 99 minutes. Temperature from 1 to 80 °C. Suitable for cleaning 3D printed models with resin.

Ref.	100150	100152
Power ult.	120 W	180 W
Power cal.	100 W	200 W
Capacity	2.800 ml	5.800 ml
Frequency	40 khz	40 khz
Height	245 mm	290 mm
Width	300 mm	365 mm
Depth	165 mm	180 mm
Weight	3.98 kg	5.4 kg

 (L) 240 x (W) 345 x (H) 310 mm	 4.5 kg
--	--



## Ultrasonic bath 2,5 L. Ref. 100140



Very comfortable and practical for cleaning small objects in the Dental Laboratory and Clinic. Its 2.5-litre capacity tank is the right size for holding the most commonly used dental laboratory instruments. It has a heating system and an electronic timer.

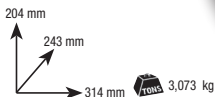

Voltage	230 V 50/60 Hz
Power	80 W
Capacity	2500 ml.
Frequency	35 khz

(L) 360 x (W) 275 x (H) 240 mm 3,500 kg

## Ultrasonic bath, 3 L. Ref. 100142

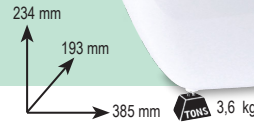

For cleaning small objects in the laboratory and dental practice. With detachable cable, drain valve and hose. Includes plastic protective basket and drain hose.

Voltage	220-240 V	Capacity	3000 ml
Power	150 W	Frequency	36 kHz

## Ultrasonic bath 1.4 L. Ref. 100141



Essential machine in both Dental Lab and Clinic. Real power of 60 W. that guarantees an excellent cleaning power. It has an electronic timer with 7 segments display.

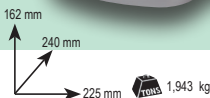

Voltage	230 V 50/60 Hz
Power	60 W
Capacity	1400 ml
Frequency	42 khz

(L) 430 x (W) 270 x (H) 270 mm 2,500 kg

## Ultrasonic baths

### (mini) Ref. 100144

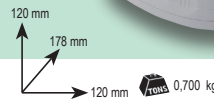

Voltage	230 V 50/60 Hz
Power	21 W
Capacity	140 ml
Frequency	42 khz

### (for denture cleaning) Ref. 100160

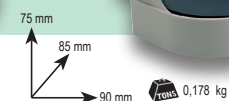

Voltage 2 batteries AA

Batteries not included

## Intraoral camera (autofocus) Ref. 100335



High resolution with 2.000.000 pixels. Autofocus function. WIFI image transmission. 15 inches LCD screen. Camera holder.

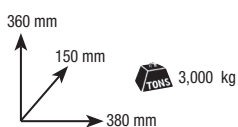

(L) 420 x (W) 100 x (H) 410 mm 3,900 kg

## Whitening lamp Ref. 100340



Wide lighting range (from 420 to 472 nm) and high power (up to 2000 mW/cm<sup>2</sup>). Easily adjustable in height and orientation due to its practical curved arm. Its digital display shows the power, times, etc. of the whitening process. It also has a remote control. It is factory supplied complete, ready for use, and with 20 disposable mouth splints, two protection goggles, and a lip retractor.

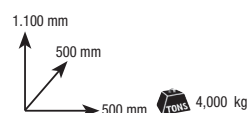

(L) 615 x (W) 350 x (H) 300 mm 7,000 kg

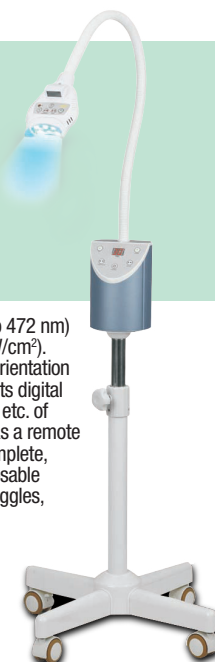

## Whitening lamp Ref. 100341



- Wide spectrum of illumination.
- 5 Blue lights: from 430 to 490 nm.
- 2 high power Red lights: 610 to 650 nm.
- 3 different types of LED light sources: blue, red, (red + blue).
- Light output power: up to 2,327 mW / cm.
- 8 purple lights with sterilization effect.
- Made of metallic material, in appearance elegant and easy to assemble.
- Adjustable bleaching time.
- Power supply: 100-240 V, 50/60 Hz.

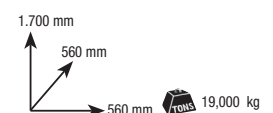

(L) 670 x (W) 400 x (H) 300 mm 21,2 kg

## Endodontics motor (wirelessly)

Ref. 100350

Optimized design for user interface  
Ergonomic and compact body.  
5 memory programs.  
From 100 to 600 r.p.m.  
Auto and Autostop inverse functions.



Maximum	100-600 rpm
Torque	1-4 N.cm
Power	230 W
Power supply	Battery

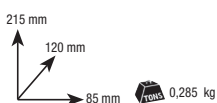

(L) 240 x (W) 170 x (H) 80 mm 0,725 kg



## Apex locator Ref. 100330

Automatic calibration, LCD display clear and accurate image.  
Different colours.  
Sterilizable accessories.  
Rechargeable battery.



(L) 230 x (W) 155 x (H) 112 mm 0,800 kg

## Gutta Percha Cutter

Ref. 100349

The tip is flexible design to let you cut smoothly.

Press the power button and the tip can heat up to 500 °C immediately.

Release the power button and the tip can cool down fast.

Put tip cap back after using.

Put GP Cut back on stand base.



Voltage	2 AA batteries (DC 3V)
Temp. Reach	Over 500 degree
Cool down period	Less than 1 second
Stand base size	3 cm x 2.5 cm
3 Tips	(L: 2.0 mm; M: 1.2 mm; S: 0.5 mm)

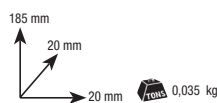

(L) 180 x (W) 70 x (H) 35 mm 0,122 kg

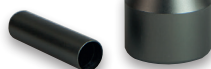

## D3 tabletop ultrasonic scaler

Ref. 100313



(Scaling-Periodontics)

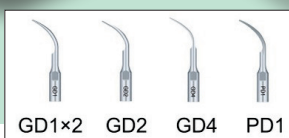

Voltage	100-240 V 50/60 Hz, 30 VDC
Power	3-20 W
Frequency	28 +-3khz
Pressure	0.1-5 bar (0.01-0.5 MPa)

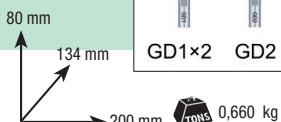

(L) 375 x (W) 305 x (H) 115 mm 2,620 kg

## D5 tabletop ultrasonic scaler

Ref. 100316



(Scaling-Periodontics-Endodontics)

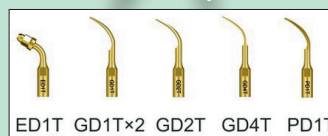

Voltage	100-240 V 50/60 Hz, 30 VDC
Power	3-20 W
Frequency	28 +-3khz
Pressure	0.1-5 bar (0.01-0.5 MPa)

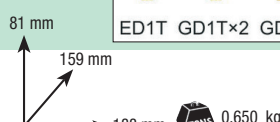

(L) 375 x (W) 305 x (H) 115 mm 2,610 kg

## D7 tabletop ultrasonic scaler

Ref. 100318



Scaling + Periodontics + Endodontics with liquid reservoir or drug treatment.  
Satelec handpiece, removable and autoclavable at 135° type with 8 point-inserts

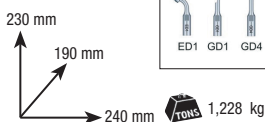
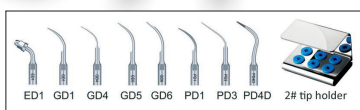

(L) 360 x (W) 250 x (H) 185 mm 2,712 kg

## Composite heater

Ref. 080077



Device to keep composite syringes warm

SPECIFICATIONS

Height	135 mm
Width	97 mm
Depth	110 mm
Weight	0,742 kg
Temperatura	40-50 y 70°C
Diameter of holes	16 mm
Voltage	100-240 V

## LED C. curing light

Ref. 100320

Battery powered, it has a desktop base/charger, with no uncomfortable cables in the lamp. Its surprising lightness makes it a very pleasant working tool.  
The optical fibre tube is very easy to dismount and sterilize.  
The light pulses can be regulated in four different ways.



Voltage	100-240 V 50/60 Hz
Light output	850-1000 mW/cm²
Weight	0,120 kg
Size	263 x Ø 23 mm

(L) 230 x (W) 75 x (H) 170 mm 0,639 kg



## Biological spores incubator

Simple and easy to use spore incubators. They are essential to carry out the necessary tests that confirm the proper performance of the sterilization devices. Two models are available: Elite, with digital display and adjustable temperature; and Practic, very functional and economical. Both have four cameras to be able to perform as many verifications at the same time. The Elite model also has a screen that indicates the temperature at which the test is performed and the time remaining until it ends. Its electronic control also alerts of anomalies such as power outages to avoid incorrect results.

Both devices perform the test at 57.5 °C, although the Elite model also allows operation at 35 °C depending on the type of spores used.

**35 °C +- 2,5 °C for Bacillus Subtilis**  
**57,5 °C +- 2,5 °C for Geobacillus Stearothermophilus**

Ref.	Elite R-100370	Practic R-100375
Voltage	230 V 50/60 Hz	90-250 V 50/60 Hz
Consumption	25 W	10 W
Operating temperature	57,5 +- 2,5 °C e 35 +- 2,5 °C	57,5 °C
Height	80 mm	90 mm
Width	105 mm	75 mm
Depth	165 mm	75 mm
Weight	0,750 kg	0,239 kg



Ref. 100370

Ref. 100375

(L) 210 x (W) 260 x (H) 175 mm 1,100 kg

(L) 103 x (W) 110 x (H) 95 mm 0,300 kg

**Inox**



## Tank for distilled water

Ref. 080620

A tank specially designed for the storage and supply of distilled water under pressure in the dental sector. Made of stainless steel, it features a pressure regulator and a double safety valve. Before filling the tank, it must be properly cleaned and sterilized. Do not use detergents containing hydrochloric acid, hypochlorous acid, etc. Pressure: 5 bar. Conection: Ø 6 mm. Made of stainless steel, it features a pressure regulator and a double safety valve.

Height	680 mm
Width with pressure regulator	255 mm
Diameter	225 mm
Weight	4,700 kg
Capacity	18 litres



## Distiller/decalcifier Ref. 100210

Simply fill the tank with tap water to get 4 litres of distilled water in around 5 hours. The cleaning of the tank is easy and quick. The water produced is very pure (between 2 and 10 mg/ litre of solid residue) and can be used in a large number of applications in the dental clinic and laboratory (autoclaves, creation of compounds, steam generating machines, etc.). The appliance is supplied with a 4-litre PVC tank, a set of activated carbon filters and a can of citric acid to clean the tank.

**IMPORTANT**- The water supplied for the appliance is "DISTILLED". However, it cannot be used for syringes, vials, cleaning wounds and generally any surgical application that requires TRI-DISTILLED purity.



Distiller cleaner refill (500 g.) **R-100210-01**

Spare still filters (6 u.) **R-100210-02**



Voltage	230 V 50/60 Hz
Power	580 W
Capacity	4 l.

365 mm  
 280 mm  
 250 mm 3,500 kg

(L) 285 x (W) 285 x (H) 400 mm 5,068 kg

## icanCLAVE

**Autoclave D118-18 L**  
class B Ref. 100365



### Features

- Class B 18-liter desktop autoclave.
- High quality internal components of Italian, Japanese and American brands.
- ODE valves.
- ULUAK vacuum pump.
- ULKA water pump.
- Ultra quiet (noise level below 70 dB).
- Triple fractionated vacuum system with an independent steam generator, which guarantees fast and safe sterilization cycles.
- High precision control system for perfect sterilization results (EN13060).
- Self-diagnosis with error codes.
- Fully automatic with pre-programmed sterilization cycles.
- Stainless steel chamber and door, with electro-polished finish.
- Open type water tank, which allows easy filling and cleaning.



Bacteriological Filter



## Interface

- Very simple interface, which allows the professional to work safely for its easy handling, offering confidence to the clinics and their patients.
- LCD screen, which shows information about the cycle process: time, temperature, pressure, process alert.
- Different languages to choose from: Spanish, English, German, French, Italian, Dutch, Polish, Romanian, Czech, Latvian, Lithuanian, Hungarian and Chinese.

## Sterilization control.

- Print the sterilization report and display available in several languages.
- Includes USB and printer.
- The data of the last 20 cycles can be automatically saved in the system and printed on your PC.

## Security

- Test: Vacuum test / Bowie & Dick test / Helix test.
- Class B models include cycles for hollow loading type A and type B in addition to a specific cycle for prions.
- The double door protection system prevents the cycle from starting if the door is not locked correctly. This system also prevents the door from opening if the pressure inside the chamber is not equal to the atmospheric pressure outside the chamber.
- Pressure safety valve prevents overpressure in the chamber and steam generator.
- The power supply is automatically cut if there is a short circuit or an electrical fault capable of detecting and identifying the exact cause of any problem and issuing a specific error code to the operator.
- Water tank water level switch that controls the maximum and minimum water level.
- Automatic warning for maintenance.

safety lock



## Regulations



- 97/23/EEC Pressure Equipment Directive.
- Regulation (EU) 2017/745 on medical devices (MDR)
- EN13060 Small steam sterilizers.
- EN61326, EN 61000 Electromagnetic compatibility.
- EN61010-1, UL 61010-1 Safety requirements.
- EN61010-2-040, IEC 61010-2-040 Specific requirements for steam sterilizers used for treatment of medical materials.
- EN13485: 2012/AC:2012
- ISO 13485:2003

## Official technical service ICANCLAVE in Spain

## TECHNICAL CHARACTERISTICS

Voltage	220-240 V 50/60 Hz
Camera dimensions	247 / 350 mm
Circuit breaker	F16 A / 400 V
Nominal Power	1750 V
Sterilization Temperatures	121 /134 °C
Distilled water tank capacity	2.5 litros
Operating Temperature (°C)	5-40
Relative operating humidity	Max. 80 % not condensed
Height	450 mm
Width	490 mm
Depth	600 mm
Weight	47 kg
Max level of noise	< 70 dB
Atmospheric operating pressure (kPa)	76-106



 (L) 690 x (W) 575 x (H) 525 mm  51 kg

## Automatic bag sealer Ref. 080435

Steri. Date: 20200512 Exp. Date: 20200611 Batch No.: 00000000 Operator: Higienista Department: Seccion esteril Note: Prog. envuelto ID: D119C032

- 7" touch screen with indications.
- Quick heating system for a perfect seal.
- The sealing temperature can be regulated by the user.
- Its integrated printer allows marking the obtained records, for a correct traceability, both in the clinic and in the laboratory.
- In accordance with standards ISO11607-2: 2006 and EN868-5-2009



Sealing speed	10 m/minute
Temperature	60-220°C
Sealing pressure	86 N
Power	500 W
Dimensions	635 x 240 x 200 mm
Weight	17 kg

Optional roller  
Ref. 080436

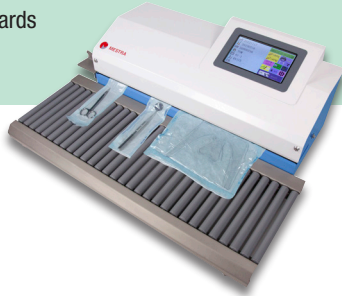

## Bag sealer Ref. 080433

Simple and nice looking bag sealer. Despite its small size, it has a sealing length of 305 mm and a sealing width of 12 mm. These features are similar to those of sealers of much higher cost. It is ideal for the dental clinic.

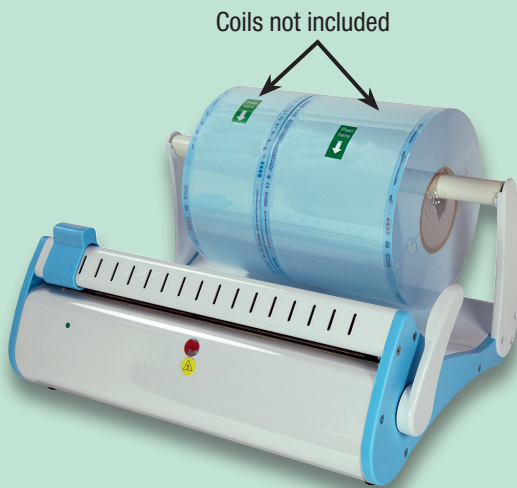

Coils not included

Height	210 mm
Width	430 mm
Depth	335 mm
Weight	6.5 kg
Voltage	230 V 50/60 Hz
Power	100 W

(L) 500 x (W) 415 x (H) 245 mm 8.7 kg

## Sterilization rolls

Ref. 080447

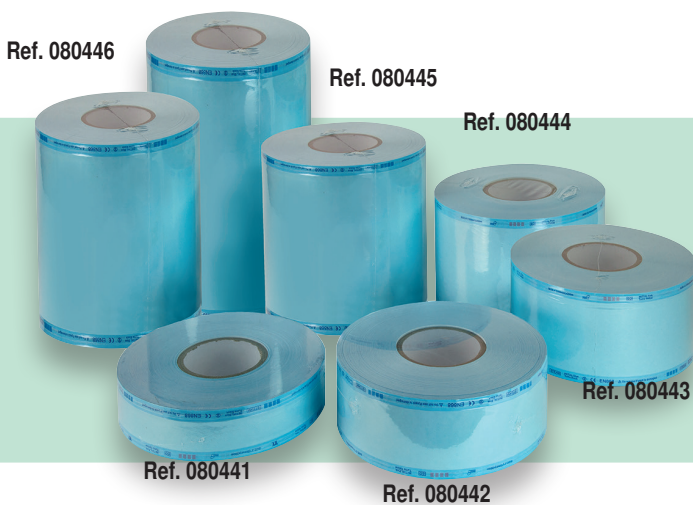

Ref. 080446

Ref. 080445

Ref. 080444

Ref. 080443

Ref. 080441

Ref. 080442

Ref. 080441	5 cm x 200 m
Ref. 080442	7.5 cm x 200 m
Ref. 080443	10 cm x 200 m
Ref. 080444	15 cm x 200 m

Ref. 080445	20 cm x 200 m
Ref. 080446	25 cm x 200 m
Ref. 080447	30 cm x 200 m

## Self-sealing sterilization pouch

New bags 5x9 cm  
The smallest on  
the market!



200 units  
per package

Ref. 080448	5 x 24 cm
Ref. 080449	7 x 26 cm
Ref. 080450	9 x 26 cm
Ref. 080451	5 x 9 cm
Ref. 080452	14 x 28 cm

Ref. 080454	19 x 36 cm
Ref. 080456	25 x 40 cm
Ref. 080457	30 x 40 cm
Ref. 080458	30 x 45 cm
Ref. 080459	5.7 x 13 cm

Class I medical device  
(MDR 2017/745) Conforming to  
standards ISO 11607-1:201  
and EN 868-5:2009

## Air purifiers

Family of air purifiers of three different sizes. They act on the stale air in any room, eliminating dust, dirt and germs. After the treatment, the air is much cleaner and more breathable. It should be emphasized that poor air quality favors the appearance of diseases, especially of a respiratory type.

The purification process begins with a battery of filters of three different levels: bacterial HEPA, activated carbon and photocatalytic. Subsequently, a high-performance UV lamp continues the cleaning work.

**\* Purification is completed with ionization and the possibility of activating an ozone generator.** After the treatment, we can speak of a highly purified and quality air. There are three different sizes depending on the volume of the room to be treated.



**Purifier 25 m<sup>2</sup>**  
Ref. 100510



**Purifier 30-35 m<sup>2</sup>**  
Ref. 100512



**Purifier 60-70 m<sup>2</sup>**  
Ref. 100514

### SPECIFICATIONS

	Ref. 100510	Ref. 100512	Ref. 100514
Height	303 mm	536 mm	570 mm
Width	329 mm	360 mm	370 mm
Depth	170 mm	206 mm	265 mm
Weight	4 kg	6,3 kg	8,5 kg
Power supply	220-240 V 50 Hz	220-240 V 50 Hz	220-240 V 50 Hz
Power	36 W	45 W	72 W
Noise	≤40 dB(A)	≤45 dB(A)	≤45 dB(A)
Purificated volume	150 m <sup>3</sup> /h	280 m <sup>3</sup> /h	560 m <sup>3</sup> /h
Recommended purification area	25 m <sup>2</sup>	30-35 m <sup>2</sup>	60-70 m <sup>2</sup>
3-level filtration (HEPA, activated carbon, catalytic)	yes	yes	yes
UV cleaning + Ionization	yes	yes	yes
UV lamp frequency	254 nm	254 nm	254 nm
* Ozone generator	yes	yes	-
Remote control	yes	yes	yes
Indicators of: temperature, humidity, air quality, filter change	yes	yes	yes



## UV cabinets

Family of UV sanitizers of three different sizes. The effectiveness of ultra violet rays is known to eliminate germs from any surface. In the field of hygiene, they are widely used in different sectors: the elements to be sanitized are introduced into the chamber where they will be subjected to UV light for a defined time. After the process, a good part of the microorganisms present will have disappeared.

### Ref. 100500

Ideal for small objects such as mobile phones, masks, key rings, coins, jewelry, etc. Highly recommended for personal use. With drying function through heating resistance.



### Ref. 100502

Medium-sized. Its camera allows to process the same type of articles as the previous model, but in greater quantity; or if you prefer, larger objects. Ideal for clinics and laboratories.



### Ref. 100504

The interior of the cabinet is made entirely of easy-to-clean stainless steel. Contains 10 levels of trays in which instruments can be stored. The deposited elements will be subjected to the action of UV rays.



Reference	100500	100502	100504
Height	120 mm	300 mm	500 mm
Width	296 mm	290 mm	350 mm
Depth	195 mm	200 mm	260 mm
Weight	1 kg	4,5 kg	8 kg
Power supply	110-240 V 50 Hz	220 V 50 Hz	220 V 50 Hz
Power	150 W	4 W	15 W
Timer	10 min.	0-60 min/continuous	0-999 min



## Purifier / Nebulizer Ref. 100520

High efficiency purifier-nebulizer device, capable of atomizing the disinfectant solution creating a very fine mist that penetrates every corner.

- The droplet size can be adjusted, as well as the jet launch distance.
- Using the appropriate products, it is possible to efficiently disinfect large surfaces in just a few minutes (up to 100 m<sup>2</sup> in just 10 minutes).
- Its 5 l tank. allows spraying many square meters on a single charge.
- The reduced weight of the nebulizer - about 3 kg -, together with the practical banner tape that is included, allows a comfortable, efficient and safe use.
- The device is essential to disinfect medium-sized surfaces.

Height	250 mm
Length	570 mm
Width	335 mm
Weight	2,7 kg
Voltage	230 V. / 50 Hz.
Rated power	1.000 W
Capacity	5 l.
Spray volume	470 ml/ mi.
Droplet size	Ajustable 100um y 150 um
Launch range	Adjustable: 3-8 m.

## Extraoral suction system Ref. 100347



Position the mouthpiece next to the patient's mouth and avoid the spread of all types of aerosols, particles in suspension, vapors and odors in the clinic. Greatly reduce the risk of cross contamination between professionals and patients and protect respiratory health.



### Product description

- Two power levels.
- 2 filter cartridges composed of: Coarse filter for small particles.
- Active carbon filter. HEPA H13 filter.
- UV light.
- Plasma generator.
- Ergonomic shape and easy to move to have a good working position.
- Semi-rigid suction arm, self-supporting and easy to clean.
- Easy cleaning housing.
- Hours of use counter.\*

### Technical characteristics

- Two power levels (50-100%).
  - Noise: ≤60 dB.
  - Flow: 4000 L / min.
  - Maximum vacuum: -25 kPa.
  - UV lamp: 254 nm (approximate life 10000 h).
  - Plasma generator: 5000 V (plasma 20000 h).
  - Hepa grade: H13 (0.3 µm, > 99.97%).
- \* More than 12 h. continuous work without overheating.

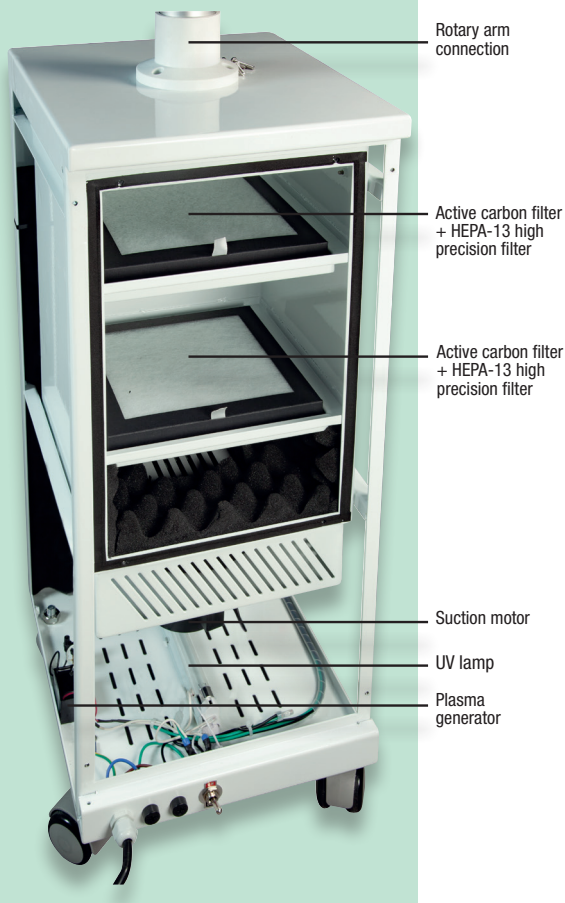

### SPECIFICATIONS

Height (arm not included)	755 mm
Width	330 mm
Depth	320 mm
Weight (arm included)	30 kg
Power supply	220 V, 50/60 Hz
Consumption	1000 W
Arm length	1,3 m.

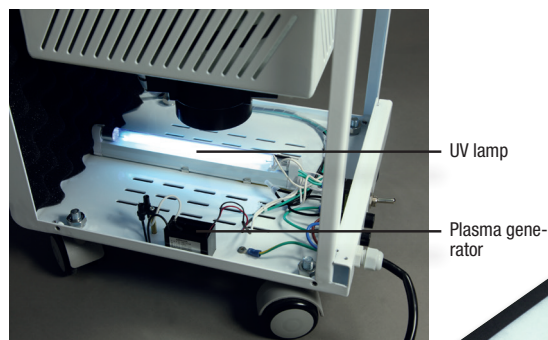

**\* Observation for maintenance:**  
It is recommended to replace the filter element after one year of use.

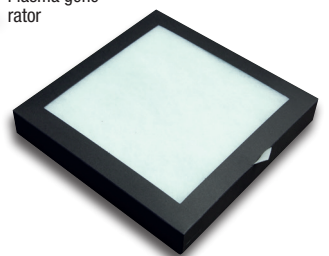

## Worktable (Kit) Ref. 100301 K2

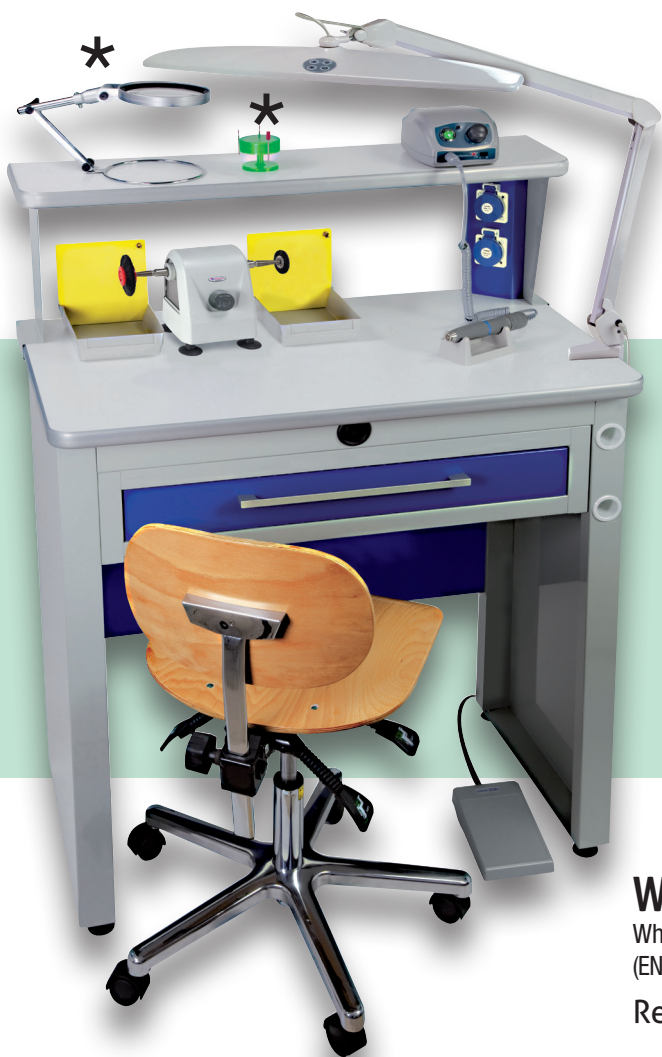

- Metal table, wooden tabletop.
- Work chair.
- Polisher + 2 trays.
- Micromotor.
- LED lamp.

### FREE GIFT:

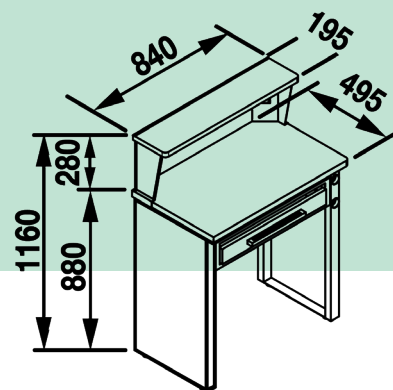

- \* Table magnifier.
- \* Magnetic bur holden.



### Work chair

Wheels with safety brakes  
(EN 1335-2: 2009)



Ref. 100300

 (L) 950 x (W) 610 x (H) 100 mm  63 kg

## Worktable Ref. 100301

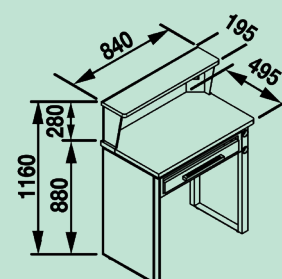
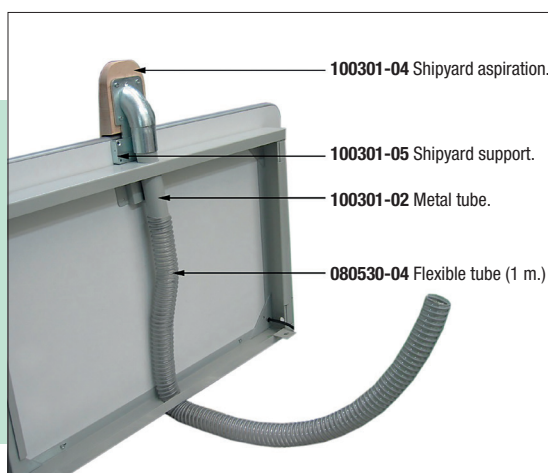
Metal work table with wooden worktop.  
Assembly is simple.  
They have all the elements and accessories for work in dental environments: 2 sockets, shelf, drawer, etc.



 (L) 900 x (W) 600 x (H) 660 mm  46 kg





Without wheels  
Ref. 100297



With wheels  
Ref. 100298

1 lifting movement

## Work chairs

Work chairs specially designed for the dental laboratory. Comfortable, ergonomic and easy to clean. Allow 1 seat height adjustment. The material used is spongy polyurethane in black.

	Ref. 100297	Ref. 100298
Max. seat height	660 mm	555 mm
Min. seat height	460 mm	420 mm
Seat dept	450 mm	450 mm
Seat widt	460 mm	460 mm
Weight	9 kg	8 kg

## Work chair

Ref. 100299



4 different regulations allowed: seat height and inclination and backrest height and angle of inclination.

Max. height	555 mm
Min height	420 mm
Depth	450 mm
Width	460 mm
Weight	10.3 kg

Wheels with safety brake  
(EN 1335-2:2009)



## Work chair

Ref. 100300



4 different regulations allowed: seat height and inclination and backrest height and angle of inclination.

Wheels with safety brake  
(EN 1335-2:2009)

Max. seat height	515 mm
Min. seat height	390 mm
Seat depth	420 mm
Seat width	420 mm
Weight	9 kg

(L) 610 x (W) 610 x (H) 325 mm 10.5 kg

## Electric mobile trolley

Ref. 100307

Made of steel sheet and enameled in white.

3 trays of 290 x 396 mm.  
3 sockets to power the equipment.  
4 wheels with smooth and balanced movement.  
Weight supported per tray: 5 kg

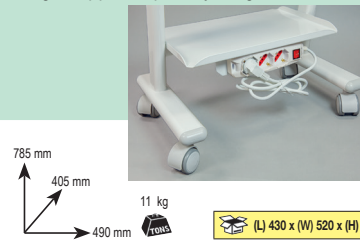

(L) 430 x (W) 520 x (H) 860 mm 12 kg



## Electric mobile trolley

Ref. 100305

Made of steel sheet and enameled in white.  
3 trays of 40 x 30 cm.  
2 sockets to power the equipment.  
4 wheels with smooth and balanced movement.

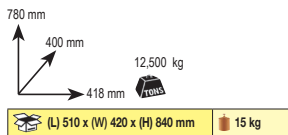

(L) 510 x (W) 420 x (H) 840 mm 15 kg



## Electric mobile trolley

Ref. 100306

Made of steel sheet and enameled in white.

3 glass trays.  
2 sockets to power the equipment.  
4 wheels with smooth and balanced movement.

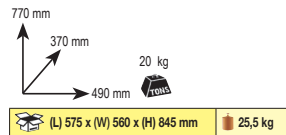

(L) 575 x (W) 560 x (H) 845 mm 25,5 kg



## Electric mobile trolley

Ref. 100309

Electric mobile trolley with wheels for the dental clinic. Made of resin and steel sheet enameled in white.

3 sockets to power the equipment.  
3 drawers.  
1 power sockets.  
White colour.  
Smooth glide.

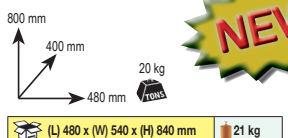

(L) 480 x (W) 540 x (H) 840 mm 21 kg



## Electric mobile trolley

Ref. 100308



Made of steel sheet and enameled in white.  
3 trays of 290 x 396 mm.  
3 sockets.  
1 drawer.  
4 wheels with smooth and balanced movement.  
Weight supported per tray: 5 kg

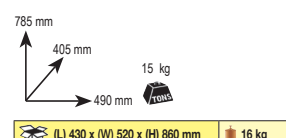

(L) 430 x (W) 520 x (H) 860 mm 16 kg





## LED lamp

(articulated arm)

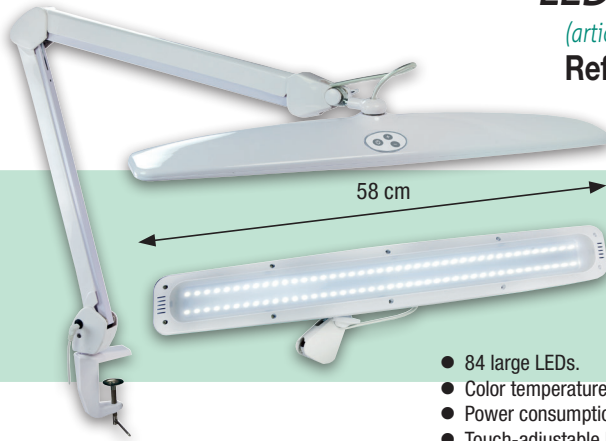
Ref. 100288



- 84 large LEDs.
- Color temperature 6000 - 7000 K
- Power consumption 2 to 21 W
- Touch-adjustable light intensity
- Free of Flicker effect
- With clamp for fastening to the table
- Highly resistant articulated arm

 (L) 760 x (W) 285 x (H) 120 mm  2,9 kg



## LED lamp

(articulated arm)

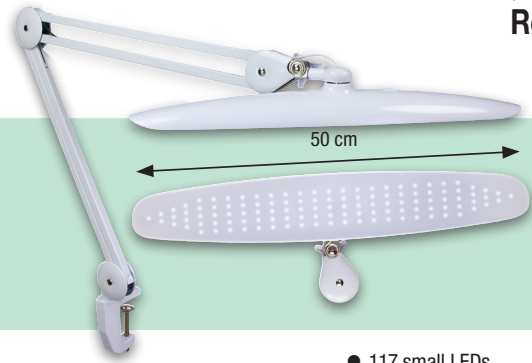
Ref. 100290



- 117 small LEDs.
- Color temperature 600 - 6000 K
- Power consumption 6 to 24 W
- Free of Flicker effect
- With clamp for fastening to the table

 (L) 680 x (W) 220 x (H) 130 mm  2,6 kg

## LED lamp

(articulated arm)

Ref. 100289

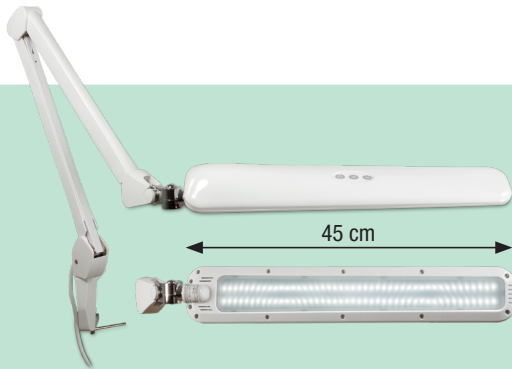

- 90 LEDs grandes
- Color temperature 6000 - 7000 K
- Touch-adjustable light intensity
- With clamp for fastening to the table

 (L) 555 x (W) 420 x (H) 75 mm  2,9 kg



## Magnifying glass with LED lamp

(3 diopter lens) Ref. 100287

(5 diopter lens) Ref. 100287-5x



- 90 white LEDs
- 3 - 5 diopter lens
- Ø 120 mm lens
- Clamp to fix it to the table

 (L) 540 x (W) 255 x (H) 110 mm  3 kg

## Accessories

for lamps and magnifying glass

Ref. 100287 - 100287-5X - 100288 - 100290

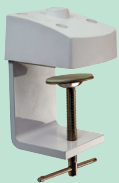

Ref. 100288-02  
(Clamp support)



Ref. 100288-03  
(wall bracket)



Ref. 100288-10  
(Lamp base)



Ref. 100288-04  
(Screwable table support)

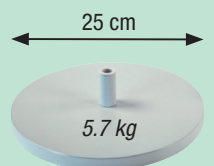

Ref. 100288-07  
(Desktop stand)

## Anodizing unit



**Solution of water (600 ml)  
and sodium bicarbonate (20 g)**

### Ref. 100295

This device allows you to process titanium dental elements quickly, easily and economically. The results are comparable to products belonging to a much higher category.

- ✓ Corrosion resistance.
- ✓ Wear resistance.
- ✓ Better adhesion and surface finish.
- ✓ Less release of metal ions.
- ✓ It works with a solution of water and sodium bicarbonate.

Dimension 207 x 245 x 160 mm
Weight: 2,73 kg
Voltage: 10-65 V
Power supply: AC220-240 V, 50/60 Hz
Power: 100 W
Anodizing time: 5 seconds

### Appearance:

The anodic layer can be colored with different shades, giving the titanium a more attractive appearance than the original taupe.



## Aspirations Sirocco

The modular nature of this range of aspiration units, provides solutions for clinic and laboratory, allowing the user to choose unit size, arm type, filtering system, etc.

The S model incorporates two stages of HEPA filtration. (high efficiency particle filter). Besides, an external micro-motor detection system and power adjustment in seven levels are also included.

The M and L models are sturdy aspirations, silent and highly reliable. The M is practical for use under the work table and the L (with a big capacity) for CAD/CAM aspiration systems. They incorporate an external connection to a micromotor and a milling machine that will allow to work synchronously with the unit.

- ✓ Motor de inducción (sin escobillas)
- ✓ Induction motor (brushless).
- ✓ Amazing suction power.
- ✓ Efficient low noise aspiration (55 dB).
- ✓ Easy removal and cleaning of the filters.

### Sirocco S specifications

Height 135 mm • Width 280 mm • Depth 280 mm • Weight 3.1 kg • Power 350 W

### Sirocco M specifications

Height 580 mm • Width 290 mm • Depth 330 mm • Weight 11 kg • Power 800 W

### Sirocco L specifications

Height 800 mm • Width 290 mm • Depth 330 mm • Weight 13 kg • Power 800 W



Sirocco S with clinical working box  
**Ref. 080534AC**



Sirocco M with flexible tube  
**Ref. 080536D1**



Sirocco L with flexible tube  
**Ref. 080537D**

## Sense A7 - Induction

Ref. 100230

- ✓ Brushless motor.
- ✓ Manual or pedal speed control.
- ✓ Displayed speed.
- ✓ Right & Left turning ability.
- ✓ Overload protection function.
- ✓ Fault warning function.



Specifications
Dimension 185 x 175 x 128 mm
Weight: 4,27 kg
Maximum speed: 55000 rpm
Torque: 8.5 N-cm
Power: 240 W
Output voltage: 0-36 V
Handpiece weight: 230 g



## Sense A3 - Brushes

Ref.: 100238 (white)

- ✓ Motor with brushes.
- ✓ Manual or pedal speed control.
- ✓ ON/OFF pedal.
- ✓ Displayed speed.
- ✓ Right & Left turning ability.
- ✓ Overload protection function.
- ✓ Fault warning function.



Specifications
Dimension 147 x 120 x 88 mm
Weight: 1,15 kg
Maximum speed: 35000 rpm
Torque: 3.0 N-cm
Power: 70 W
Voltage: 0-33 V
Handpiece weight: 215 g
Standard chuck: Ø2.35 mm

Also available  
in graphite color  
(ref.: 100240)



## Sense A6 - Induction

Ref.: 100232 (white)

- ✓ Brushless motor.
- ✓ Manual or pedal speed control.
- ✓ Automatic speed maintenance function.
- ✓ High/Medium/Low speed.
- ✓ Displayed speed.
- ✓ Right & Left turning ability.
- ✓ Overload protection function.
- ✓ Fault warning function.



Specifications
Dimension 246 x 162 x 102 mm
Weight: 2,47 kg
Maximum speed: 55000 rpm
Torque: 8.0 N-cm
Power: 230 W
Voltage: 0-36 V
Handpiece weight: 240 g



Also available  
in graphite color  
(ref.: 100234)

## Prime 221 - Induction

Ref.: 100236

- ✓ Brushless motor.
- ✓ Manual or pedal speed control.
- ✓ Displayed speed.
- ✓ Right & Left turning ability
- ✓ Overload protection function.
- ✓ Fault warning function.



Specifications
Dimension 191 x 130 x 90 mm
Weight: 2,8 kg
Maximum speed: 50000 rpm
Torque: 5.8 N-cm
Power: 120W
Voltage: 0-36 V
Handpiece weight: 205 g



## TITAN 8 (ref. 100202)

Is the first option.  
Distilled Water is loaded directly into the boiler.

## TITAN AUTOFILL (ref. 100203)

It also has a pump to suck distilled water from an external bottle.

- ✓ Made of stainless steel with high quality components.
- ✓ Digital pressure switch.
- ✓ Full and lack of water indicator.
- ✓ Connection cable with built-in differential switch.
- ✓ Drain tap with safety lock.

Specifications 100202 and 100203
Height 36 cm
Width 27 cm
Depth 42 cm
Power 2200 W
Tensión 220 V, 50/60 Hz
Pressure 8 bar
Weight 12,5 kg
Boiler 3 L



Ref. 100202



Ref. 100203

**Professional use**

### Additional Information: 100202, 100203, 100204

They are supplied with the following accessories:

- ✓ Power cord with built-in protection.
- ✓ Fine and long replacement nozzle.
- ✓ Replacement safety cap and 2 gaskets.
- ✓ Funnel and measuring cup (300 ml).

In models with direct connection to the water intake:

- ✓ Necessary hoses for water inlet/outlet connection.

Ref. 100202	Ref. 100203	Ref. 100204
✓ Manual filling.	✓ Manual filling.	✓ Manual filling.
	✓ Autofill without previous cooling (external bottle).	✓ Autofill without previous cooling (integrated tank).
		✓ Direct water net connection.

## TITAN PLUS (ref. 100204)

Also has an internal tank for distilled water storage. You can load water into this extra tank without having to turn off the machine and wait for the pressure inside the boiler drops. Simply open the auxiliary tank cap and pour more water when you need it.

Safer and without interruptions.



Specifications 100204
Height 38 cm
Width 37 cm
Depth 45 cm
Power 2600 W
Tensión 220 V, 50/60 Hz
Pressure 4 - 8 bar
Weight 18 kg
Boiler 3 L
Auxiliary tank 2 L



Distilled water tank



**Professional use**



## Finishing box *Eclipse* with built-in suction Ref. 080217

Box with similar features to the Eclipse finishing cabin (Ref. 080216), but with the particularity of integrating its own aspiration unit. Its small dimensions make it ideal in places with little space, where it is important to keep the environment clean without the need for bulky vacuum equipment. If necessary, it is possible to incorporate the machine to an external suction source.

Height	275 mm	Length	400 mm
Width	360 mm	Weight	2,8 kg

 (L) 410 x (W) 370 x (H) 370 mm	 3,800 kg
--	--

## Steam Machine

They are ideal for cleaning tasks in dental laboratories due to their abundant flow of dry steam. Both devices are supplied with water level meter and funnel.

Reference	100195	100196
Height no holder	290 mm	280 mm
Height with holder	685 mm	680 mm
Width	235 mm	400 mm
Depth	335 mm	325 mm
Weight	6.2 kg	11.3 kg
Power	1250 W	2250 W
Pressure	4 bar	4 bar
Capacity	3.5 L	5 L

Moderate use



## Ultrasonic cleaning device Ref. 100162

Ultrasonic cleaning device for dental elements, with a UV lamp that is used to disinfect during cleaning. Its 28 W of power ensures excellent results. Its small dimensions make it suitable for home environments and travel. It also has a digital timer.

Height	122 mm	Depth	104 mm
Width	122 mm	Weight	2,8 kg
Tank	Ø 87*38 mm	Capacity	180 ml
Frecuency	42 kHz	Timer	5/10 min

Moderate use









Description	Page	Description	Page
ADERER PLIERS	6	DAPPEN GLASSES	5
AIR PURIFIER	35	DECANTER	22
ALCOHOL LAMP	9	DENTAL FILM CLIPS	17
ALGINATE BOWL	5	DEVELOPER MANUAL	17
ALGINATE CONTAINER	24	DISINFECTANT, NEBULIZER	36
ALGINATE MIXER	24	DISPENSER FOR COTTON ROLLS	10
ALGINATE SPATULA STAINLESS STEEL	5	DISPENSER OF GLASSES	10
ALGINATE, BOWL	5	DISTILLED WATER, TANK	31
AMALGAM APPLIER	7	DISTILLER - DECALCIFIER	31
ANGLE PLIERS	6	DOSE MEASURING SPOON	18
APEX LOCATOR DPEX III	30	DOUBLE GUIDE OCCLUSOR	4
ARC FOR COFFERDAM HOLDING	7	DRYING OVEN	25
ARTICULATORS	3-4	ELECTROLYTIC BATH	38
ASPIRATION	23-24	ENDO MOTOR	30
AUTOCLAVE	32	ENDODONTIA BOX	14
AUTOSEALING BAGS FOR SEALING MACHINE	34	ENDODONTIA, RULE FOR MEASURING FILES	14
BAGS FOR SEALING MACHINE, AUTOSEALING	34	EOLO	23
BASE MODELFORMER	7	EXTRAORAL SUCTION UNIT	38
BIOLOGICAL INDICATOR INCUBATOR	31	FACE BOW	3
BOBBIN FOR SEALING MACHINE	34	FACE PROTECTION	16
BOX FOR DENTURES	10	FILM CLIPS	17
BOX FOR ENDODONTIA	14	FINISHING BOX CLINIC	24
BOX FOR ORTHODONTIC MODELS	11	FINISHING TABLE	39
BOX FOR ORTHODONTIC PLATES	10	FORMING SHEETS	27
BOX FOR ORTHODONTIC PLATES	10	FOX PLANE	7
BOX FOR PROTHESIS	10	GASKETS FOR FORMING	27
BOXES	11	GEMINI	23
BOXES FOR MODELS	12	GERMICIDE BOX (FOR BURS)	9
BOXES FOR TRANSPORT	12	GLASSES, DAPPEN	5
BUR CLEANER TWEEZERS	7	GLASSES, DISPENSER	10
BUR STAND	9	GUN FOR SANDBLASTING	23
CALIPER	17	GUTTA PERCHA CUTTER	30
CALLYPSO	28	HAMMER FOR CROWN REMOVING	7
CAMERA, INTRAORAL	29	HANDLE FOR MIRRORS	7
CARVERS PK THOMAS	6	HANDLE FOR MORSE POINT	7
CEMENT SPATULA	6	HEAD MAGNIFIER	17
CHAIR FOR WORK	40	HEATER FOR COMPOSITES	30
CHEEK RETRACTOR	7-8	HOLDER FOR INSTRUMENTS	6
CICLON	23	HOLDING CLAMPS FOR WELDING	16
CLAMP HOLDER	6	IMPRESSION TRAYS	15-16
CLAMPS HOLDER	6	INCUBATOR FOR BIOLOGICAL INDICATOR	31
CLIPS FOR DENTAL FILM	17	INSTRUMENT TRAY	14
COFFERDAM HOLDING ARC	7	INTRAORAL CAMERA	29
COMPOSITE HEATER	30	IVORY TYPE DAM PERFORATOR	6
COMPRESSORS	27	LAMP FOR ALCOHOL	9
CONTAINER FOR ALGINATE	24	LAMP FOR TEETH WHITENING	29
CONTAINER FOR MODELS	11	LED LAMP	38
CORD	10	LIQUID DOSIFIER	10
COTTON CONTAINER	9	LOCATOR, APEX	30
COTTON ROLL DISPENSER	10	MACHINES	21
CROWN REMOVING HAMMER	7	MAGNETIC INSTRUMENTS RACK SUPPORT	5
CUTTER FOR GUTTA PERCHA	30	MAGNETIC STAND	9
CUTTING PLIERS	7	MAGNIFIER FOR HEAD	17
DAM PERFORATOR	6	MAGNIFIER GLASSES	16

Description	Page	Description	Page
MAGNIFYING GLASS	38	STERILIZATOIN, BOX FOR BURS	9
MATHIEU PLIERS	6	SUCTION UNIT	23-24
MATRIX RETAINERS	7	SUCTION UNIT, EXTRAORAL	38
MCROMOTOR	27-28	SUNTION UNIT, WET RING	27
MINI SANDBLASTING	23	SUPPORT FOR PLIERS	6
MIRROR HANDLE	7	SUPPORT FOR INSTRUMENTES, MAGNETIC RACK	5
MIRRORS	5	SUPPORT RAIL FOR MODEL TRAY	13
MIXER FOR SILICONE	24	TABLE FOR FINISHING	39
MIXING MORTAR	7	TANK FOR DISTILLED WATER	31
MIXING TIPS	15	TEETH WHITENING LAMP	29
MODEL CONTAINER	11	TERMOPLAST	25
MODEL TRAY	13	TIPS FOR MIXING	15
MODEL TRIMMER	19-20-21	TONGS FOR STERILIZATION	7
MORSE POINT HANDLE	7	TRANSPORT BOXES	12
MORTAR FOR MIXING	7	TRAYS FOR IMPRESSION	15-16
MOTOR FOR ENDO	30	TRIMMER FOR MODELS	21
MULHACEN	19	TROLLEY	38
NAPKIN HOLDER	7	TWEEZERS BUR-CLEANER	7
NEBULIZER FOR DISINFECTANT	36	ULTRASONIC CLEANERS	18-28-29
<b>NEW PRODUCTS</b>	<b>43</b>	ULTRASONIC SCALER	30
ORION	23	UV RAY SAFETY SCREEN	16
ORTHODONTIC PLATES BOX	10	UV SANITIZER CABINET	36
OVER FOR DRYING	25	UV, PROTECTION GOGGLES	16
PK THOMAS CARVERS	6	VACUUM FORMER	25
PLASTER SPATULA	5	VIBRATOR	22
PLASTPRESS	25	WALDSACHS PLIERS	6
PLATES FOR FORMING	27	WATER BATH	26
PLIERS RACK SUPPORT	6	WAX MODELING CARVERS PK THOMAS	6
POLIMERIZATION LAMP LED.C	30	WEINGART PLIERS	6
POLISHING BOX	22	WELDING, HOLDING CLAMPS	16
POLISHING LATHE	22	WET RING SUCTION UNIT	27
PRECISION	18	WHITENING, TEETH LAMP	29
PRESSURE FORMER	25	WORK BOX	23
PRESSURE FORMER - PLASTPRESS	25	WORK CHAIR	40
PROTHESIS BOX	10	X-RAY VIEWER	18
PURIFIER FOR AIR	35	X-SAY VIEWER	18
RAIL FOR MODEL TRAY	13		
REAL FOR SEALING MACHINE	34		
RETRACTOR FOR CHEEKS	7-8		
RULE FOR MEASURING FILES	14		
SAFETY GOGGLES	16		
SANDBLASTER	22		
SANITIZER, UV	36		
SCHWARZ PLIERS	6		
SEALING MACHINE	34		
SILICONE MIXER	24		
SILICONE PISTOL	15		
SIROCCO	24		
SPATULA FOR ALGINATE	5		
SPATULA FOR CEMENT	6		
SPATULA FOR PLASTER	5		
SPOON FOR DOSE MEASURING	18		
STAND FOR BURS	9		
STERILIZATION, TONGS	7		



**MESTRA**

**Talleres Mestraitua SL**  
(+34) 944 530 388  
info@mestra.es - www.mestra.es  
48150 SONDIKA (Spain)



Management System  
ISO 9001:2015

www.tuv.com  
ID 1100018003